



2020 Products Catalog



MILESTONES

- 2000. May. - TAEJIN Technology founded and started producing voltage regulator ICs
- 2002. Dec. - ISO 9001 certified
- 2003. Sep. - Designated as "Korea Venture Company"
- 2006. Jul. - "INNO-BIZ certification" (Grade : Aa) acquired
- 2006. Sep. - Designated as "Specialized Components & Materials Company" by Korean Ministry of Commerce, Industry, and Energy
- 2006. Nov. - Awarded the "USD 5 million in export"
- 2007. Jun. - Participated Korean Gov.'s "Enterprise for Developing Technology of Component & Materials"
- 2007. Nov. - ISO14001 certified
- 2010. Jun. - Designated as "Technological Innovation Company" by Korean Ministry of Knowledge Economy
- 2010. Nov. - Awarded the "USD 10 million in export"
- 2011. Aug. - Acquired "Green Certification"
- 2015. Oct. - Selected as Technological Innovation Company by the Small & Medium Business Administration
- 2017. Jul. - Launched "AEC-Q100" Qualified Products

PRODUCTION PROCEDURE

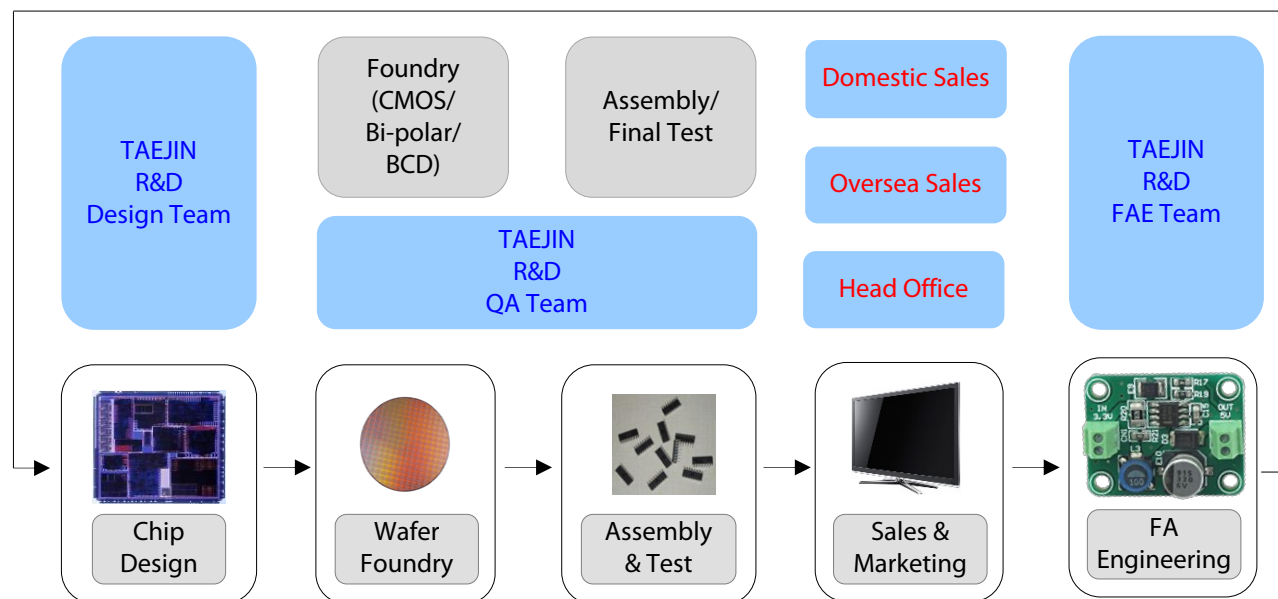

HIGH QUALITY POWER ICs

Reliable Power Supply Systems with High Quality Power ICs

TAEJIN Technology, a power management IC specialist, has been focused on developing linear and switching power ICs and peripherals for power systems of various electronic systems for years and has achieved highly reliable cost-effective power system operation.

Power ICs & Peripherals Line-Up

- Full Line-Up of Linear Regulators
- High Voltage Non-Sync DC-DC Converters
- DC-DC Converter Controllers
- RS-232/ RS-485 Interface ICs
- Logics & Drivers
- Amplifiers, Comparators and other Peripherals

Full Quality and Supply Chain Control

- Verified Control Plan for Manufacturing
- Qualified by JESD22 Quality Assurance Test
- Qualified by AEC-Q100 Qualification
- Industry Leading Manufacturing Partners
- Sub-Contractor Control Based on BCP
- Experienced Failure Analysis Engineering

Leading Technology

- In-House Silicon Proven Precision Analog IPs
- Domestic & International Patents
- Capable of Application Specific Custom ICs

Full System Level Support

- Experienced Field Application Engineering
- Comprehensive Application Support
- Design, Test and Evaluation Support

INTERNATIONAL PATENTS



KOREA Patent

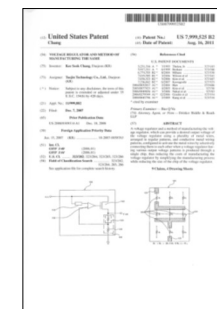

US Patent



JAPAN Patent



CHINA Patent



TAIWAN Patent

ENVIRONMENTAL DECLARATIONS

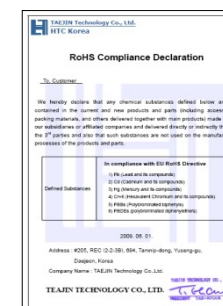

RoHS Compliance



Non-use of PFOS, PFOA, DMF

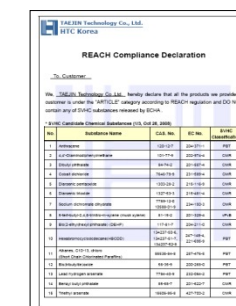

REACH Compliance



Halogen-Free (only for Green Items)

DOMESTIC REGISTERED PATENTS (KOREA)

- 10-0442936: Regulator circuit for generating of stability voltage
- 10-0456194: Regulator circuit for generating of stability voltage
- 10-0523799: Regulator circuit for generating of stability voltage
- 10-0617966: Switching control regulator circuit for generating of stability voltage
- 10-0665454: Switching control regulator circuit for generating of stability voltage
- 10-0813200: Regulator circuit for generating of stability voltage
- 10-0836529: Regulator circuit for generating of stability voltage
- 10-0900266: Overheat protection circuit of a regulator
- 10-0900267: Sub-1V output Voltage regulator of ultra low dropout type
- 10-0902084: Voltage regulator and fabrication method there of
- 10-0930275: Band Gap Reference Using CMOS
- 10-1184994: Fusing circuit
- 10-1247219: Current limit circuit
- 10-1268314: Waveform generator
- 10-1299212: LED Switching Driver
- 10-1301260: Soft Start Circuit
- 10-1306865: High Voltage IC
- 10-1306866: Circuit for Preventing a Miss-operating by Reverse Current Detector
- 10-1319827: Current Limit Apparatus
- 10-1414712: DC-DC Converter System
- 10-1447189: Level Shifter
- 10-1453005: Apparatus for Driving Light Emitting Diode
- 10-1453003: DC-DC Converter
- 10-1461066: Current Control Signal Generator
- 10-1475740: Waveform Generator
- 10-1532241: Waveform Generator
- 10-1630600: Voltage regulator having overcurrent protection circuit
- 10-1741170: Voltage regulator having overcurrent protection circuit
- 10-1696403: Soft Start Circuit of Switching Regulator
- 10-1773814: Reverse Current Protection Circuit of Switch Device
- 10-2001449: Soft-start circuit with hiccup operation and power converting apparatus including the same
- 10-2005044: Switching regulator using ESR emulation
- 10-2103998: Multi-functional enable circuit capable of variation function with hysteresis characteristics using a current-source
- 10-2207264 : Reference Voltage Generator

INTERNATIONAL REGISTERED PATENTS

USA

- US 7,629,783 B2: Ultra Low Dropout Voltage Regulator
- US 7,999,525 B2: Voltage Regulator and Method of Manufacturing the Same

CHINA

- 705345: 超低压降型电压调节器
- 1049457: 电压调节器其制造方法

TAIWAN

- 381264: Voltage Regulator and Method of Manufacturing the Same
- 373699: Ultra Low Dropout Voltage Regulator

JAPAN

- 2007301057: 超低压降型电压レギュレーター

AEC-Q100 QUALIFICATION

AEC-Q100	AEC-Q101	AEC-Q200
Qualification for Integrated Circuits (ICs)	Qualification for Discrete Semiconductors (Transistor/Diode, etc)	Qualifications for Passive Components (Resistor/Capacitor, etc)

AEC-Q100 is the reliability evaluation standard for integrated circuits (ICs).
The standard specifies 4 grades according to available temperature range.
The standard is suitable for evaluating automotive semiconductors that require high reliability.

Grade Level	Ambient Operating Temperature Range
GRADE 0	-40°C to +150°C
GRADE 1	-40°C to +125°C
GRADE 3	-40°C to +105°C
GRADE 3	-40°C to +85°C

AUTOMOTIVE APPLICATIONS

Grade Level	Category	Applications
Power Supplies for Automotive System	Infotainment	- Car Navigation, ITS/GPS, Connectivity Audio, Car Stereo - Cluster, Rear-Seat Monitor, Drive Recorder, T-Box
	Convenience	- HAVC (Heating, Ventilation, and Air Conditioning) - ADAS, Roof Control, Seat Control, Charger, Car Lighting
	Body	- Power Door, Power Window, Mirror Control

AEC-Q100 QUALIFIED PRODUCTS

Device Name	CH.	V _{OUT} [V]	V _{IN_MAX} [V]	I _{OUT_MAX} [A]	V _{DROP_TYP} [V]	I _{Q_TYP} [mA]	PKG
TJ4303GSF5-xx-Q1	Single	ADJ	6	0.3	0.20	0.10	SOT-23-5L
TJ4310GDP-xx-Q1	Single	ADJ	6	1.0	0.35	0.15	SOP-8PP
TJ4310GQ-xx-Q1	Single	ADJ	6	1.0	0.35	0.15	DFN2x3-8
TJ5641GDP-xxxx-Q1	DUAL	1.0~3.3	6	0.6	0.24	0.14	SOP-8PP
TJ5205DP-xx-Q1	Single	ADJ/2.0~8.5	16	0.15	0.165	0.12	SOP-8PP
TJ5205SF5-xx-Q1	Single	ADJ/2.0~8.5	16	0.15	0.165	0.12	SOT23-5
TJ4320GQ-xx-Q1	Single	ADJ	6	2.0	0.40	0.20	DFN2x3-8

Device Name	Standards	A _{VIN} [V]	P _{VIN} [V]	V _{DDQ} [V]	V _{OUT} [V]	I _{SINK & I_{SOURCE}} [A]	PKG
TJ2998GDP-Q1	II/III/III/IV	3.0 ~ 5.5	0 ~ 2.0	1.2 ~ 1.8	V _{TT} / V _{REF}	2.0(Cont.) / 3.0(Peak)	SOP-8PP

Device Name	V _{OUT} [V]	V _{FB} [V]	V _{IN_MAX} [V]	I _{OUT_MAX} [A]	F _{SW} [KHz]	PKG
LM2576DP-xx-Q1	ADJ / 3.3 / 5.0 / 12 / 15	1.230	40	3.0	52	SOP-8PP
LM2576HVDP-xx-Q1	ADJ / 3.3 / 5.0 / 12 / 15	1.230	60	3.0	52	SOP-8PP

CUSTOM IC DEVELOPMENT : LDO VARIATIONS

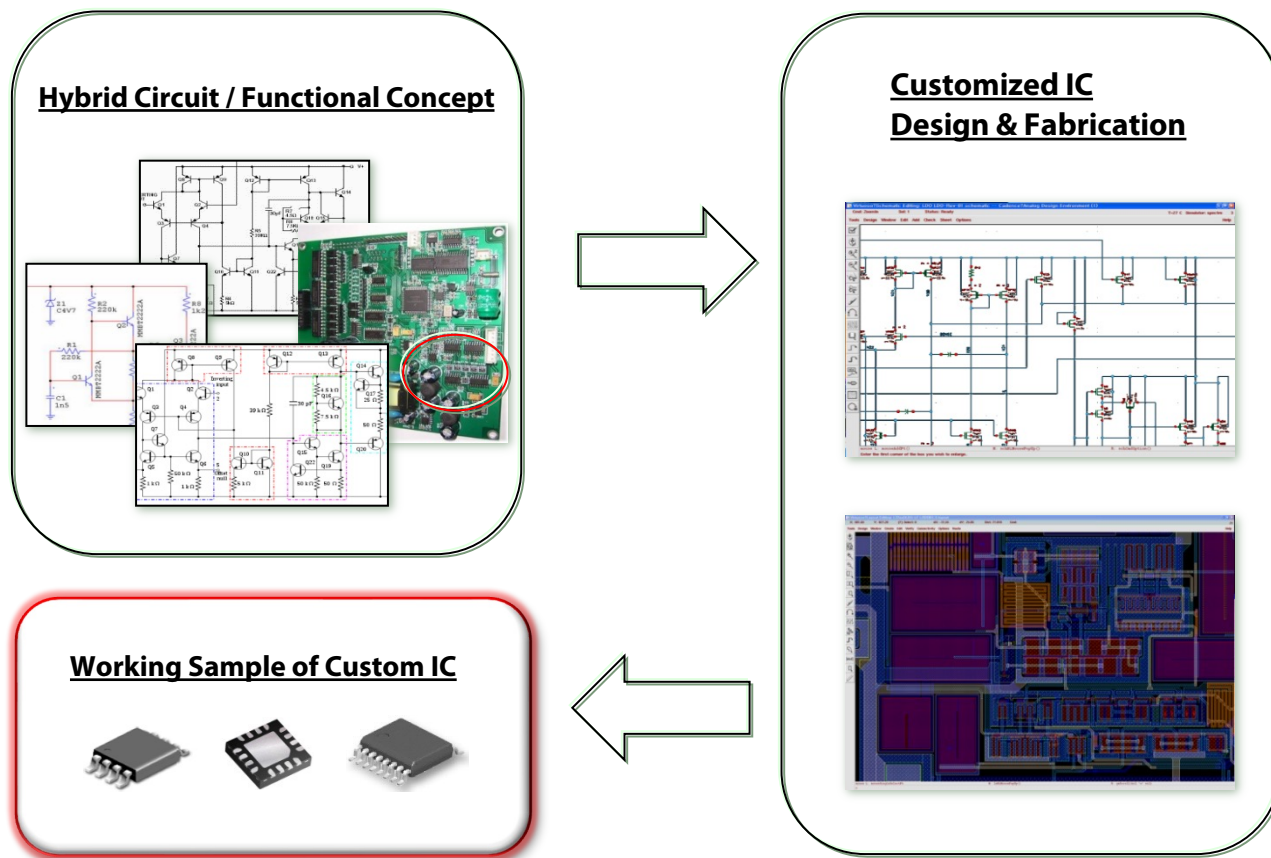

SILICON-PROVEN PRIMITIVE IPs for CUSTOM ICs

- * Bandgap References
 - CMOS BGR/ High PSRR CMOS BGR/ Low Voltage CMOS BGR
- * Low Input Voltage Reference Generator
- * Ramp Generator/ Multiple Ramp Generator with Adjustable Phase Shift
- * Current Limiter
 - Constant Current Limiter/ Foldback Current Limiter/ Cycle by Cycle Current Limiter
- * Reverse Current Protection for Power Distribution Switches and DC-DC Converters
- * Internal Fixed Soft Start/ Programmable Soft Start with External Components
- * Under Voltage Lock Out with/without Deglitch
- * Over Temperature Protection/ Short Circuit Protection
- * Power Good Monitor with/without Deglitch
- * Wave Generator
 - Adjustable Oscillator/ Clock Generator
 - Ramp Generator/ Multi-Ramp Generator with Phase shift
- * Bootstrap using MOS Switch for High Side NMOS Switch for DC-DC Converter
- * Other Primitives as 2-Stage AMPs/Folded Cascode AMPs/High Speed Comparators/ etc.

➔ All IPs for Power ICs are designed, verified and “**modularized**” for fast design Turnaround. These proven IPs are the core of competitiveness not only for custom IC service but also for high reliability and effective design optimization of catalog products.

ELECTRONIC MODULES

High quality electronic modules are designed and produced using our own genuine ICs. Custom electronic modules for application specific demand can be designed and produced.

L293D Motor Shield Module for Arduino

FEATURES

- 2 connections for 5V 'hobby' servos connected to the Arduino's high-resolution dedicated timer - no jitter
- 4 H-Bridges: L293D chipset provides 0.6A per bridge (1.2A Peak) with thermal shutdown protection, internal kickback protection diodes. Can run motors on 4.5VDC to 25VDC.
- Up to 4 bi-directional DC motors with individual 8-bit speed selection
- Up to 2 stepper motors (unipolar or bipolar) with single coil, double coil or interleaved stepping.
- Pull down resistors keep motors disabled during power-up
- Big terminal block connectors to easily hook up wires (18-26AWG) and power
- Arduino reset button brought up top
- 2-pin terminal block and jumper to connect external power, for separate logic/motor supplies

DESCRIPTION

The L293D Motor Shield is a great motor controller for Arduino. It control servos, steppers and DC motors with an Arduino.

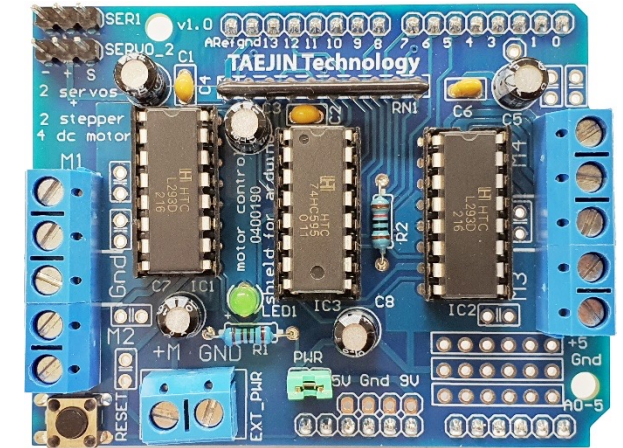

ORDERING INFORMATION

Part Number	MMS0293-01
Device	L293D Motor Shield Module
Package	Assembled Module

APPLICATIONS

- Robotics
- Mechatronics
- Simple to medium-complexity projects

LM2596 Buck Converter Module

FEATURES

- LM2596 DC-DC Buck Converter Step Down Module.
- Input voltage range: DC 4V to 35V. (input voltage must be higher than the voltage output to 1.5V or more can not be boosted.)
- Output voltage range: 1.25V to 30V DC voltage is continuously adjustable, high efficiency and maximum output current of 3A.
- Output current: Rated current 2A, maximum 3A. (Heat sink required)
- Switching frequency: 150kHz.
- All solid capacitors and High-Q inductors.

DESCRIPTION

The LM2596 Buck Converter Module is a non-isolated step-down DC-DC converter with non-synchronous rectification.

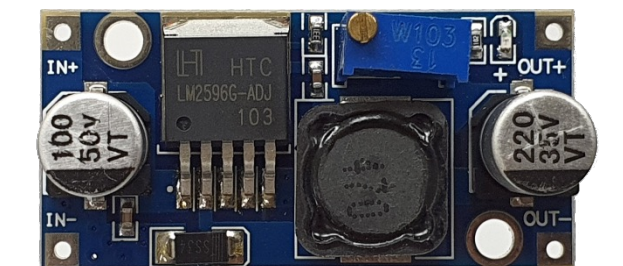

ORDERING INFORMATION

Part Number	MBS2596-01
Device	LM2596 Buck Converter Module
Package	Assembled Module

APPLICATIONS

- Simple high efficiency step-down regulator
- On-card switching regulator
- Efficient pre-regulator for linear regulators

PRODUCT INDEX

High Performance Linear Power IC

TPS761xx	150mA Low Noise VLDO Voltage Regulator	SOT-23-5L
TPS73001	300mA Adjustable Output CMOS ULDO Voltage Regulator	SOT-23-6L
TPS730xx	300mA Fast Transient Fixed Output CMOS ULDO Voltage Regulator	SOT-23-5L
TPS740xx	600mA CMOS LDO Voltage Regulator	SOT-23-5L
TPS1117LVxx	1.0A Fixed Output ULDO Voltage Regulator	SOT-223-3L
TPS7A8001	1.0A Adjustable Output ULDO Voltage Regulator	DFN3x3-8
TPS7A7001	2.0A Adjustable Output ULDO Voltage Regulator	SOP-8PP
TPS7A7002	3.0A Adjustable Output ULDO Voltage Regulator	SOP-8PP
TPS7A4501	1.5A High Input Voltage Adjustable Output VLDO Voltage Regulator	TO-263-5L
TPS75701	3.0A High Input Voltage Adjustable Output VLDO Voltage Regulator	TO-263-5L
TPS75501	5.0A High Input Voltage Adjustable Output VLDO Voltage Regulator	TO-263-5L
TPS2553D	Single Adjustable Current Limit up to 2.25A Power Distribution Switch	SOT-23-6L
LP2998	DDR Memory Termination Voltage Regulator (MLCC Applicable)	SOP-8PP

60V Operative Non-Synchronous DC/DC Converter

LM2575HV	1.0A Step-Down Voltage Regulator (52KHz)	SOP-8PP/ TO-263-5L/ TO-220-5L
LM2576HV	3.0A Step-Down Voltage Regulator (52KHz)	SOP-8PP/ TO-263-5L/ TO-220-5L
LM2596HV	3.0A Step-Down Voltage Regulator (150KHz)	SOP-8PP/ TO-263-5L/ TO-220-5L

Dual Channel CMOS ULDO (Ultra Low Drop Out) Voltage Regulator (Low ESR MLCC Applicable)

LM2C1117	600mA Dual Channel ULDO Voltage Regulator	SOP-8PP
TJ5641	600mA Dual Channel ULDO Voltage Regulator	SOP-8PP

CMOS ULDO (Ultra Low Drop Out) Voltage Regulator (Low ESR MLCC Applicable)

TJ9198	300mA Low Input Low Output, Low Quiescent CMOS LDO	DFN1x1-4/ SC-70-5L/ SOT-23-3/-5L
TJ4303	300mA ULDO Voltage Regulator	SOT-23-5L
LM1108	300mA CMOS LDO Regulator	SOT-23-3L/ SOT-89-3L
LM8805	600mA CMOS LDO Regulator	SOT-23-5L/ SOT-89-3L
TJ1119C/F	1.0A ULDO Fixed Output Voltage Regulator	SOT-223-3L/ TO-252-3L
TJ1801	1.0A ULDO Voltage Regulator	SOP-8PP
TJ4310	1.0A ULDO Voltage Regulator	SOP-8/-8PP/ SOT-89-5L/ DFN2x3-8
LD39150	1.5A ULDO Voltage Regulator	TO-252-5L
TJ2132	Sub-1V Output Low Vin 2.0A ULDO Voltage Regulator	SOP-8PP/ DFN3x3-8
TJ4320	2.0A ULDO Voltage Regulator	SOP-8PP/ TO-252-5L
TJ4330	3.0A ULDO Voltage Regulator	SOP-8PP/ TO-252-5L
TJ2134/A	Sub-1V Output Low Vin 4.0A ULDO Voltage Regulator	SOP-8PP

OCP IC

TJ2242	Single Adjustable Current Limit USB Power Switch	SOT-23-6L
TJ2242A	Single Adjustable Current Limit USB Power Switch	SOT-23-6L
TJ82034	2.5A Current Limit USB Power Switch	SOP-8

DDR Memory Termination Regulator (Sink/ Source Linear Regulator)

TJ2998	DDR Memory Termination Voltage Regulator (MLCC Applicable)	SOP-8/ SOP-8PP
---------------	--	----------------

VLDO (Very Low Drop Out) Voltage Regulator

TJ75xxA	100mA CMOS Low Dropout Regulator	SOT-89-3L/ SOT-23-5L
LM2950/1	100mA LDO Voltage Regulator	TO-92/ SOP-8
LM2950G	100mA LDO Voltage Regulator	TO-92/ SC-70-5L
LP2981	100mA Low Noise & High PSRR LDO Regulator	SOT-23-5L
TJ5205	150mA Low Noise & High PSRR LDO Regulator	SOT-23-5L/ SOP-8/ SOP-8PP
LP2985	150mA Low Noise & High PSRR LDO Regulator	SOT-23-5L
LM9076	150mA Low IQ LDO with Delayed Reset Output	SOP-8/ TO-263-5L
TJ62FPxx	250mA Low Dropout Voltage Regulator	SOT-23-3L/ SOT-89-3L
TJ75xx	250mA CMOS Low Dropout Regulator	TO-92/ SOT-89-3L
LP2954	250mA LDO Voltage Regulator	TO-92/ TSOP-8/ TO-263/ TO-220
LM2940	1.0A LDO Regulator	SOT-223/ TO-220
LM2940H	1.0A High-Voltage LDO Regulator	SOT-223/ TO-220
LM2941	1.0A Adjustable LDO Regulator	TO-263-5L
LM3710x	1.0A High-Voltage Very Low-Dropout Voltage Regulator	SOP-8/ TO-252/ SOT-223
LM37102C	1.0A High-Voltage Very Low-Dropout Voltage Regulator (MLCC)	SOP-8/ SOP-8PP
LM3910x	1.0A High-Voltage Very Low-Dropout Voltage Regulator	SOT-223/ SOP-8/ TO-252
LM2915x	1.5A High-Voltage Very Low-Dropout Voltage Regulator	TO-252/ TO-263/ TO-220
LM3930x	3.0A High-Voltage Very Low-Dropout Voltage Regulator	TO-263/ TO-220
LM2930x	3.0A High-Voltage Very Low-Dropout Voltage Regulator	TO-263/ TO-220
LM39502	5.0A High-Voltage Very Low-Dropout Voltage Regulator	TO-263/ TO-220

LDO (Low Drop Out) Voltage Regulator

LM1117	1.0A LDO Fixed & Adjustable Voltage Regulator	SOT-89-3L/ SOT-223/ TO-252
LM1117G	1.0A LDO Fixed & Adjustable Voltage Regulator	SOT-23/ SOT-223
LM1086	1.5A LDO Fixed & Adjustable Voltage Regulator	TO-252/ TO-263
LM1085	3.0A LDO Fixed & Adjustable Voltage Regulator	TO-252/ TO-263
LM1084	5.0A LDO Fixed & Adjustable Voltage Regulator	TO-252/ TO-263

PRODUCT INDEX

Standard Linear Voltage Regulator

LM78Lxx	100mA Positive Fixed Voltage Regulator (5V~24V)	TO-92/ SOT-89-3L/ SOP-8
TJ78L05	100mA Positive Fixed Voltage Regulator (5V, MLCC Applicable)	SOT-89-3L
LM79Lxx	100mA Negative Fixed Voltage Regulator (-5V~-24V)	TO-92/ SOT-89-3L
LM317L	100mA Adjustable Voltage Regulator	TO-92/ SOT-89-3L/ SOP-8
LM78Mxx	500mA Positive Voltage Regulator (5V/15V)	TO-252-3L
LM79Mxx	500mA Negative Voltage Regulator	TO-220F-3L
LM317	1.5A 3-Terminal Adjustable Regulator	SOT-223/ TO-263-3L/ TO-220-3L
LM78xx	1.5A Positive Voltage Regulator	TO-263-3L/ TO-220-3L
LM79xx	1.0A Negative Voltage Regulator	TO-220-3L

Interface IC

MAX232E	RS-232 Transceiver	SOP-16
MAX3232E	RS-232 Transceiver	SOP-16
MAX485E	RS-485/RS-422 Transceiver	SOP-8/ DIP-8
MAX3485E	RS-485/RS-422 Transceiver	SOP-8/ DIP-8

Converter & Controller

MC34063AG	1.5A Step-Up/Down (Inverting) Converter Controller	SOP-8/ DIP-8
MC34063C	1.2A Step-Up/Down (Inverting) Converter Controller	SOP-8/ DIP-8
LM3842/3	Current Mode PWM Controller	SOP-8/ DIP-8
TL494	Pulse-Width-Modulation Controller	SOP-16/ DIP-16
TJ9910A	Universal High Brightness LED Driver	SOP-8
TJ7660	Charge Pump Voltage Converter	SOP-8/ DIP-8
TJ1051	Constant Voltage & Current Controller (Op-Amp + V _{REF})	SOP-8/ SOT-23-6L

Amplifier & Comparator

LM358GN	Dual Operational Amplifier	DIP-8
TJ358GD	Dual Operational Amplifier	SOP-8
LM2904	Dual Operational Amplifier	SOP-8/ DIP-8
LM4558	Low Noise Dual Operational Amplifier	SOP-8/ DIP-8
TJ324GD, LM324N	Quad Operational Amplifier	SOP-14 for TJ324GD, DIP-14 for LM324N
LM2902	Quad Operational Amplifier	SOP-14 / DIP-14
OP07	Low Offset Precision Operational Amplifier	SOP-8/ DIP-8
TJ393GD, LM393GN	Dual Voltage Comparator	SOP-8 for TJ393GD, DIP-8 for LM393GN
TJ339GD, LM339N	Quad Voltage Comparator	SOP-14 for TJ339GD, DIP-14 for LM339N
LM386	Low Voltage Audio Power Amplifier	SOP-8/ DIP-8

Darlington Transistor Array

ULN2003A / 2004A	Darlington 7-Digit Transistor Arrays	SOP-16
ULN2803A	Darlington 8-Digit Transistor Arrays	SOP-18/ DIP-18
ULN62783A	Darlington 8-Digit Transistor Arrays	SOP-18/ DIP-18

Ground Fault Circuit Interrupter

GL7101	Earth Leakage Current Detector	SOP-8/ DIP-8
---------------	--------------------------------	--------------

Driver

CS8190	Precision Air-Core Tach/Speedo Driver with Return to Zero	SOP-20
L293D	Quadruple Half-H Driver	DIP-16

Voltage Reference

TL431A/C	Programmable Precision Shunt Regulator(2.495V)	TO-92/ SOT-23-3L/ SOT-89-3L
LP431A/C	Low IKA Programmable Precision Shunt Regulator(2.500V)	SOT-23-3L
LM431A	Programmable Precision Shunt Regulator(2.500V)	SOT-23-3L (Reverse Type)
TL432A/C	Programmable Precision Shunt Regulator(1.240V)	TO-92/ SOT-23-3L/ SOT-89-3L
LM336	Programmable Shunt Regulator	TO-92/ SOP-8
LM385	Micropower Voltage Reference	TO-92/ SOP-8

Logic IC

74HC00 / 04 / 14	Quad 2 Input NAND / Hex Inverters / Hex Schmitt Trigger Inverters	SOP-14/ DIP-14
74HC595	8-bit Serial-In, Serial or Parallel Out Shift register with output latches	TSSOP-16/ SOP-16/ DIP-16
CD4066B	CMOS Quad Bilateral Switch	SOP-14/ DIP-14
CD4069UB	CMOS HEX Inverters	SOP-14/ DIP-14
CD4081B	CMOS Quad 2-Input AND	SOP-14/ DIP-14
CD4093B	CMOS Quad 2-Input NAND Schmitt Trigger	SOP-14/ DIP-14

Timer

NE555	CMOS General Purpose Timer	SOP-8/ DIP-8
--------------	----------------------------	--------------

Non-Synchronous DC/DC Converter

LM2574	0.5A Step-Down Voltage Regulator (52KHz)	DIP-8/ SOP-14
LM2575	1.0A Step-Down Voltage Regulator (52KHz)	SOP-8PP/ TO-263-5L/ TO-220-5L
LM2576	3.0A Step-Down Voltage Regulator (52KHz)	SOP-8PP/ TO-263-5L/ TO-220-5L
LM2596/ LM2596G	3.0A Step-Down Voltage Regulator (150KHz)	SOP-8PP/ TO-263-5L/ TO-220-5L
LM4576	3.0A Step-Down Voltage Regulator (300KHz)	SOP-8PP/ TO-263-5L/ TO-220-5L
LM1501AG	5.0A Step-Down Voltage Regulator (150KHz)	TO-263-5L/ TO-220-5L
LM1501BG	5.0A Step-Down Voltage Regulator (300KHz)	TO-263-5L/ TO-220-5L
LM1938	0.65A Step-Up Switching Voltage Regulator (1.3MHz)	SOT-23-6L

: Products Under Development

PRODUCTS

High Performance Linear Power IC

Device Name	V _{OUT} [V]	V _{REF} [V]	V _{IN_MIN} [V]	V _{IN_MAX} [V]	I _{OUT_MAX} [A]	V _{DROP_TYP} [V]	I _{Q_TYP} [mA]	PKG
TPS761xx	ADJ/ 2.0~8.5	1.242	2.5	16	0.15	0.165 (@I _{LOAD} =0.15A)	0.120	SOT-23-5L
TPS73001	ADJ	0.6	2.5	6.0	0.3	0.20 (@I _{LOAD} =0.3A)	0.10	SOT-23-6L
TPS730xx	0.8 ~ 3.6	Fixed	2.2	5.5	0.3	0.20 (@I _{LOAD} =0.3A)	0.035	SOT-23-5L
TPS740xx	ADJ/ 1.5 ~ 6.0	1.27	2.5	6.5	0.6	0.6 ~ 1.3 (@I _{LOAD} =0.6A)	0.050	SOT-23-5L
TPS1117LVxx	1.0/ 1.2/ 1.5/ 1.8/ 2.5/ 2.8/ 3.3	Fixed	2.5	5.5	1.0	0.40 (@I _{LOAD} =1.0A)	0.13	SOT-223-3L
TPS7A8001	ADJ	0.6	2.5	5.5	1.0	0.35 (@I _{LOAD} =1.0A)	0.15	DFN3x3-8
TPS7A7001	ADJ	0.6	2.5	5.5	2.0	0.40 (@I _{LOAD} =2.0A)	0.20	SOP-8PP
TPS7A7002	ADJ	0.6	2.5	5.5	3.0	0.40 (@I _{LOAD} =3.0A)	0.20	SOP-8PP
TPS7A4501	ADJ	1.24	2.25	26	1.5	0.35 (@I _{LOAD} =1.5A)	8	TO-263-5L
TPS75701	ADJ	1.25	2.25	16	3.0	0.40 (@I _{LOAD} =3.0A)	10	TO-263-5L
TPS75501	ADJ	1.25	2.25	16	5.0	0.40 (@I _{LOAD} =5.0A)	15	TO-263-5L

Device Name	Channel	Enable Control	V _{IN} [V]	I _{CC} [μA]	I _{CON_MAX} [A]	I _{LIMIT} [A]	R _{DS,ON} [mΩ]	PKG
TPS2553D	Single	High	2.8 ~ 5.5	90	1.5	ADJ (0.2 ~ 2.25)	100	SOT-23-6L

Device Name	Standards	A _{VIN} [V]	P _{VIN} [V]	V _{DDQ} [V]	V _{OUT} [V]	I _{SINK} & I _{SOURCE} [A]	PKG
LP2998	DDR-2/3/3L/4	3.0 ~ 5.5	0 ~ 2.0	1.2 ~ 1.8	V _{TT} / V _{REF}	2.0 (Cont.) 3.0 (Peak)	SOP-8PP

60V Operative Non-Synchronous DC/DC Converter (Step-Down Switching Regulator)

Device Name	V _{OUT} [V]	V _{FB} [V]	V _{IN_MAX} [V]	I _{OUT_MAX} [A]	F _{SW} [KHz]	PKG
LM2575HV	ADJ/ 3.3/ 5.0/ 12	1.230	60	1.0	52	SOP-8PP/ TO-263-5L/ TO-220-5L
LM2576HV	ADJ/ 3.3/ 5.0/ 12/ 15	1.230	60	3.0	52	SOP-8PP/ TO-263-5L/ TO-220-5L
LM2596HV	ADJ/ 3.3/ 5.0/ 12/ 15	1.230	60	3.0	150	SOP-8PP/ TO-263-5L/ TO-220-5L

Dual Channel CMOS ULDO Voltage Regulator

Device Name	V _{OUT} [V]	V _{IN_MIN} [V]	V _{IN_MAX} [V]	I _{OUT_MAX} [A]	V _{DROP_TYP} [V]	I _{Q_TYP} [mA]	PKG
LM2C1117 (Dual CH)	1.0 ~ 3.6 (0.1V Step for both CH.)	2.5	5.5	CH1 : 0.6 CH2 : 0.6	0.24 (@I _{LOAD} =0.6A)	0.14	SOP-8PP
TJ5641 (Dual CH)	1.0, 1.2, 1.5, 1.8, 2.5, 2.8, 3.3 (For both CH.)	2.5	5.5	CH1 : 0.6 CH2 : 0.6	0.24 (@I _{LOAD} =0.6A)	0.14	SOP-8PP

PRODUCTS

CMOS ULDO Voltage Regulator

Device Name	V _{OUT} [V]	V _{REF} [V]	V _{IN_MIN} [V]	V _{IN_MAX} [V]	I _{OUT_MAX} [A]	V _{DROP_TYP} [V]	I _{Q_TYP} [mA]	PKG
TJ9198 (EN)	0.8 ~ 3.6	Fixed	2.2	5.5	0.3	0.20 (@I _{LOAD} =0.3A)	0.035	DFN1x1-4/ SC-70-5L/ SOT-23-3L/ 5L
TJ4303 (EN)	ADJ	0.6	2.5	6.0	0.3	0.20 (@I _{LOAD} =0.3A)	0.10	SOT-23-5L
LM1108	1.5 ~ 5.0	Fixed	2.5	6.5	0.3	0.3 ~ 0.6 (@I _{LOAD} =0.3A)	0.015	SOT-23-3L/ SOT-89-3L
LM8805 (EN)	ADJ/ 1.5 ~ 6.0	1.27	2.5	6.5	0.6	0.6 ~ 1.3 (@I _{LOAD} =0.6A)	0.050	SOT-23-5L/ SOT-89-3L
TJ1119C/F	1.0/ 1.2/ 1.5/ 1.8/ 2.5/ 2.8/ 3.3	Fixed	2.5	5.5	1.0	0.40 (@I _{LOAD} =1.0A)	0.13	SOT-223-3L/ TO-252-3L
TJ1801 (EN/ PG/ SS)	ADJ	0.6	1.6	5.5	1.0	0.25 ~ 0.6 (@I _{LOAD} =1.0A)	0.15	SOP-8PP
TJ4310 (EN/ PG/ SS)	ADJ	0.6	2.5	5.5	1.0	0.35 (@I _{LOAD} =1.0A)	0.15	SOP-8PP/ SOT-89-5L/ DFN2x3-8
LD39150	ADJ	0.6	2.5	5.5	1.5	0.28 (@I _{LOAD} =1.5A)	0.20	TO-252-5L
TJ2132 (EN/ PG/ SS)	ADJ	0.6	1.1	3.6	2.0	0.25 (@I _{LOAD} =2.0A)	0.10	SOP-8PP/ DFN3x3-8
TJ4320 (EN/ PG/ SS)	ADJ	0.6	2.5	5.5	2.0	0.40 (@I _{LOAD} =2.0A)	0.20	SOP-8PP/ TO-252-5L
TJ4330 (EN/ PG/ SS)	ADJ / 3.3	0.6	2.5	5.5	3.0	0.40 (@I _{LOAD} =3.0A)	0.20	SOP-8PP/ TO-252-5L
TJ2134 (EN)	ADJ	0.8	1.3	3.6	4.0	0.24 (@I _{LOAD} =4.0A)	0.15	SOP-8PP
TJ2134A (EN/ PG/ SS)	ADJ	0.8	1.3	3.6	4.0	0.24 (@I _{LOAD} =4.0A)	0.15	SOP-8PP

OCP IC

Device Name	Channel	Enable Control	V _{IN} [V]	I _{CC} [μA]	I _{CON_MAX} [A]	I _{LIMIT} [A]	R _{DS,ON} [mΩ]	PKG
TJ2242	Single	High	2.8 ~ 5.5	130	1.5	ADJ (0.2 ~ 2.25)	100	SOT-23-6L
TJ2242A	Single	High	2.8 ~ 5.5	90	1.5	ADJ (0.2 ~ 2.25)	100	SOT-23-6L
TJ82034	Single	High	2.8 ~ 5.5	80	1.5	2.5	70	SOP-8

Sink/ Source Linear Regulator

Device Name	Standards	A _{VIN} [V]	P _{VIN} [V]	V _{DDQ} [V]	V _{OUT} [V]	I _{SINK} & I _{SOURCE} [A]	PKG
TJ2998	DDR-2/3/3L/4	3.0 ~ 5.5	0 ~ 2.0	1.2 ~ 1.8	V _{TT} / V _{REF}	2.0 (Cont.) 3.0 (Peak)	SOP-8/ SOP-8PP

 : Products Under Development

PRODUCTS

VLDO (Very Low Drop Out) Voltage Regulator

Device Name	V _{OUT} [V]	V _{REF} [V]	V _{IN_MIN} [V]	V _{IN_MAX} [V]	I _{OUT_MAX} [A]	V _{DROP_TYP} [V]	I _{Q_TYP} [mA]	PKG
TJ75xxA	3.3/ 5.0	Fixed	2.7	30	0.1	0.60 (@I _{LOAD} =50mA)	0.001	SOT-23-5L / SOT-89-3L
LM2950/1	3.3/ 5.0	Fixed	4.3	30 (Absolute)	0.1	0.38 (@I _{LOAD} =0.1A)	0.075	TO-92/SOP-8
LM2950G	2.5/ 3.3/ 5.0	Fixed	4.3	30	0.1	0.38 (@I _{LOAD} =0.1A)	0.075	TO-92/SC-70-5L
LP2981 (EN)	3.3/ 5.0	Fixed	V _O +V _{DROP}	16	0.1	0.14 (@I _{LOAD} =0.1A)	0.120	SOT-23-5L
TJ5205 (EN/ Bypass)	ADJ/ 2.0~8.5	1.242	2.5	16	0.15	0.165 (@I _{LOAD} =0.15A)	0.120	SOT-23-5L/ SOP-8/ SOP-8PP
LP2985 (EN/ Bypass)	3.3/ 5.0	Fixed	V _O +V _{DROP}	16	0.15	0.165 (@I _{LOAD} =0.15A)	0.120	SOT-23-5L
LM9076 (EN/ RESET)	3.3/ 5.0	Fixed	5.35	40	0.15	0.15 (@I _{LOAD} =0.15A)	0.025	SOP-8/ TO-263-5L
TJ62FPxx	2.8/ 3.0/ 3.3	Fixed	2.5	10	0.25	0.40 (@I _{LOAD} =0.16A)	0.001	SOT-23-3L/ SOT-89-3L
TJ75xx	3.3/ 5.0	Fixed	2.7	20	0.25	0.40 (@I _{LOAD} =0.16A)	0.001	TO-92/ SOT-89-3L
LP2954	ADJ/ 5.0	1.23	6.0	30 (Absolute)	0.25	0.47 (@I _{LOAD} =0.25A)	0.090	TO-92/ SOP-8/ TO-263-3L/ TO-220-3L
LM2940	3.3/ 5.0	Fixed	4.3	30 (Absolute)	1.0	0.40 (@I _{LOAD} =1.0A)	1.0	SOT-223-3L/ TO-220-3L
LM2940H	3.3/ 5.0	Fixed	4.3	60 (Absolute)	1.0	0.40 (@I _{LOAD} =1.0A)	1.0	SOT-223/ TO-220
LM2941	ADJ	1.24	2.3	30 (Absolute)	1.0	0.40 (@I _{LOAD} =1.0A)	1.0	TO-263-5L
LM3710x (EN/ Flag)	ADJ/ 2.5/ 5.0	1.24	2.25	16	1.0	0.47 (@I _{LOAD} =1.0A)	0.70	SOT-223-3L/ SOP-8/ TO-252-5L
LM37102C (EN)	ADJ	1.24	2.5	16	1.0	0.50 (@I _{LOAD} =1.0A)	3.8	SOP-8/ SOP-8PP
LM3910x (EN/ Flag)	ADJ/ 3.3/ 5.0	1.24	2.25	16	1.0	0.41 (@I _{LOAD} =1.0A)	0.70	SOP-8/ SOT-223-3L/ TO-252
LM2915x (EN/ Flag)	ADJ/ 1.8/ 2.5/ 3.3/ 5.0/ 12	1.24	2.25	26	1.5	0.35 (@I _{LOAD} =1.5A)	8	TO-252/ TO-263/ TO-220
LM3930x (EN/ Flag)	ADJ/ 1.8/ 2.5/ 3.3/ 5.0	1.25	2.25	16	3.0	0.40 (@I _{LOAD} =3.0A)	10	TO-263/ TO-220
LM2930x (EN/ Flag)	ADJ/ 1.8/ 2.5/ 3.3/ 5.0/ 12	1.24	2.30	26	3.0	0.37 (@I _{LOAD} =3.0A)	10	TO-263/ TO-220
LM39502 (EN)	ADJ	1.25	2.25	16	5.0	0.40 (@I _{LOAD} =5.0A)	15	TO-263/ TO-220

LDO (Low Drop Out) Voltage Regulator

Device Name	V _{OUT} [V]	V _{REF} [V]	V _{IN_MIN} [V]	V _{IN_MAX} [V]	I _{OUT_MAX} [A]	V _{DROP_TYP} [V]	I _{Q_TYP} [mA]	PKG
LM1117	ADJ/ 1.2/ 1.5/ 1.8/ 2.5/ 3.3/ 5.0	1.25	2.7	20 (Absolute)	1.0	1.2 (@I _{LOAD} =1.0A)	5	SOT-223/ SOT-89-3L/ TO-252
LM1117G	ADJ/ 1.2/ 1.5/ 1.8/ 2.5/ 3.3/ 5.0	1.25	2.7	20 (Absolute)	1.0	1.2 (@I _{LOAD} =1.0A)	5	SOT-23/ SOT-223
LM1086	ADJ/ 1.5/ 1.8/ 2.5/ 3.3/ 5.0	1.25	3.0	12 (Absolute)	1.5	1.3 (@I _{LOAD} =1.5A)	5	TO-252/ TO-263
LM1085	ADJ/ 1.5/ 1.8/ 2.5/ 3.3/ 5.0	1.25	3.0	12 (Absolute)	3.0	1.3 (@I _{LOAD} =3.0A)	5	TO-252/ TO-263
LM1084	ADJ/ 1.5/ 1.8/ 2.5/ 3.3/ 5.0	1.25	3.0	12 (Absolute)	5.0	1.3 (@I _{LOAD} =5.0A)	3	TO-252/ TO-263

PRODUCTS

Standard Linear Voltage Regulator

Device Name	V _{OUT} [V]	Tolerance [%]	V _{IN_MIN} [V]	V _{IN_MAX} [V]	I _{OUT_MAX} [A]	V _{DROP_TYP} [V]	I _{Q_MAX} [mA]	PKG
LM78L05	5	2/ 4	7	20	0.1	1.7	6	TO-92/ SOP-8 / SOT-89-3L
TJ78L05	5	4	7	20	0.1	1.7	6	SOT-89-3L
LM78Lxx	6/ 8/ 9/ 10/ 12/ 15/ 18/ 24	4	8 ~ 26.5	20 ~ 39	0.1	1.7	6 ~ 6.5	TO-92 / SOT-89-3L
LM79Lxx	-5/ -6/ -8/ -9/ -12/ -15/ -18/ -24	4	-7 ~ -27	-20 ~ -38	0.1	1.7	6 ~ 6.5	TO-92 / SOT-89-3L
LM317Lx	Adjustable (1.25 ~ 37)	4	3	40	0.1	3.0	10	TO-92/ SOP-8 / SOT-89-3L
LM78Mxx	5/ 15	4	7.2/ 17.5	25/ 30	0.5	2.0	6	TO-252-3L
LM79Mxx	-5/ -6/ -8/ -9/ -12/ -15/ -18/ -20/ -24	4	-7 ~ -27	-25 ~ -38	0.5	1.6	2	TO-220F-3L
LM317	Adjustable (1.25 ~ 37)	4	3	40	1.5	3.0	10	SOT-223/ TO-263-3L / TO-220-3L
LM78xx	5/ 9/ 12	5	V _O + 2	25	1.5	2.0	8	TO-263-3L / TO-220-3L
LM79xx	5	4	V _O - 2	-25	1.0	2.0	7.8	TO-220-3L

Interface IC

Device Name	Interface	Supply Voltage [V]	Supply Current [mA]	No. of Tx	No. of Rx	Data Rate (min) [kbps]	ESD Voltage	PKG
MAX232E	RS-232	5.0	10	2	2	140	±2 kV	SOP-16
MAX3232E	RS-232	3.3 ~ 5.0	0.3	2	2	250	±15 kV	SOP-16
MAX485E	RS-485/ RS-422	5.0	0.9	1	1	5,000	±15 kV	SOP-8/ DIP-8
MAX3485E	RS-485/ RS-422	3.3	0.5	1	1	5,000	±15 kV	SOP-8/ DIP-8

Converter & Controller – Step-Up/Down Converter Controller

Device Name	Supply Voltage V _{CC} [V]	Switch Current I _{SW} [A]	Reference Accuracy [%]	Supply Current I _{CC_MAX} [mA]	Comparator Input Range V _{IR} [V]	Ambient Temp. Range [°C]	PKG
MC34063AG	40	1.5	2	4.0	-0.3 ~ 40 (Absolute)	-40 ~ 125	SOP-8/ DIP-8
MC34063C	40	1.2	2	4.0	-0.3 ~ 40 (Absolute)	-40 ~ 125	SOP-8/ DIP-8

Converter & Controller – Charge Pump Voltage Converter

Device Name	Supply Voltage [V]	Output Voltage [V]	Supply Current [μA]	Power Efficiency [%]	Frequency [KHz]	PKG
TJ7660	10.5 (Absolute)	-nV _{IN}	100	98	10	SOP-8/ DIP-8

Converter & Controller – PWM Controller

Device Name	Supply Voltage V _{CC} [V]	Reference Output V _{REF} [V]	Frequency (max) [KHz]	UVLO Threshold V _{TH} [V]	Duty Cycle (max) [%]	PKG
LM3842/3	30 (Absolute)	5	500	16/ 8.4	100	SOP-8/ DIP-8
Device Name	Supply Voltage V _{CC} [V]	Reference Output [V]	Oscillator Frequency [KHz]	Collector Output Current [A]	C-E Saturation Voltage [V]	PKG
TL494	40	5	300	0.2	1.1 (@ CE) 1.5 (@ CC)	SOP-16/ DIP-16

Converter & Controller – LED Driver

Device Name	Topology	V _{SUPPLY} [V]	Current sense pull-in threshold V _{CS(HI)} [mV]	I _{OUT} [A]	Dimming	PKG
TJ9910A	Buck	10 ~ 600	238 ~ 262	External FET	PWM/ Linear	SOP-8

PRODUCTS

Constant Voltage & Current Controller

Device Name	Supply Voltage V _{CC} [V]	Voltage Control Loop Ref. V _{REF} [V]	Transconduction Gain(V _{CTRL}) [mA/mV]	Current Control Loop Ref. V _{SENSE} [V]	Transconduction Gain(I _{CTRL}) [mA/mV]	PKG
TJ1051	12	1.21	3.5	0.2	7	SOT-23-6L/ SOP-8

Amplifier

Device Name	Type	Supply Voltage V _{CC} [V]	Input Offset V _{IO_MAX} [mV]	Differential Input V _{I(DIFF)} [V]	Input Voltage V _{IN} [V]	PKG
LM358GN	Dual	45 (Absolute)	7	45 (Absolute)	-0.3~45 (Absolute)	DIP-8
TJ358GD	Dual	45 (Absolute)	7	45 (Absolute)	-0.3~45 (Absolute)	SOP-8
LM2904	Dual	45 (Absolute)	7	45 (Absolute)	-0.3~45 (Absolute)	SOP-8/ DIP-8
LM4558	Dual	±22 (Absolute)	5	±30 (Absolute)	±15 (Absolute)	SOP-8/ DIP-8
TJ324GD	Quad	36 (Absolute)	7	36 (Absolute)	-0.3~36 (Absolute)	SOP-14
LM324N	Quad	36 (Absolute)	7	36 (Absolute)	-0.3~36 (Absolute)	DIP-14
LM2902	Quad	36 (Absolute)	7	36 (Absolute)	-0.3~36 (Absolute)	SOP-14/ DIP-14
OP07	Single	±22 (Absolute)	0.06	±30 (Absolute)	±22 (Absolute)	SOP8/ DIP8
LM386	Single	15 (Absolute)	Gain=46dB/ BW=30kHz/ THD=0.2%		± 0.4	SOP8/ DIP8

Comparator

Device Name	Type	Supply Voltage [V]	Differential Input V _{I(DIFF)} [V]	Input Voltage [V]	Input Offset V _{IO} [mV]	Input Offset Current [nA]	Input Bias Current [nA]	PKG
TJ393GD / LM393GN	Dual	±18 or 36 (Absolute)	36 (Absolute)	-0.3 ~ 36 (Absolute)	2	5	-25	SOP-8/ DIP-8
TJ339GD / LM339N	Quad	±18 or 36 (Absolute)	36 (Absolute)	-0.3 ~ 36 (Absolute)	2	5	-25	SOP-14/ DIP-14

Darlington Transistor Arrays

Device Name	Output Type	Channel	V _{CE} (Abs.) [V]	V _{IN} (Abs.) [V]	Max Collector Current [mA]	V _{CE(SAT),MAX} [V]	Input Base Resistor [kΩ]	PKG
ULN2003A	Sink	7	50	30	500	1.3 @ I _C =200mA	2.7	SOP-16/ DIP-16
ULN2004A	Sink	7	50	30	500	1.3 @ I _C =200mA	10.5	SOP-16/ DIP-16
ULN2803A	Sink	8	50	30	500	1.3 @ I _C =200mA	2.7	SOP-18/ DIP-18
TD62783A	Source	8	50	15	500	1.9 @ I _C =-225mA	2.7	SOP-18/ DIP-18

Voltage Reference

Device Name	Tolerance [%]	V _{REF} [V]	V _{KA} [V]	I _{KA_MAX} [mA]	I _{KA(MIN)_MAX} [mA]	PKG
TL431	- : 2, A : 1, C : 0.5	2.495	40	100	0.5	TO-92/ SOT-89-3L/ SOT-23-3L
LP431	A : 1, C : 0.5	2.500	36	100	0.08	SOT-23-3L
LM431	A : 1	2.500	40	100	0.5	SOT-23-3L (Reverse Pin)
TJR431	A : 1, C : 0.5	2.495	28	100	1.0	SOT-23-3L (Reverse Pin)
TL432	A : 1, C : 0.5	1.240	18	100	0.08	TO-92/ SOT-89-3L/ SOT-23-3L
LM336	2.0	2.5/5.0(Fixed)	-	10	0.6	TO-92/ SOP-8
LM385	3.0	1.2/2.5 (Fixed) 1.24 (ADJ)	-	20	0.035	TO-92/ SOP-8

GFCI - Earth Leakage Current Detector

Device Name	V _{CC,MIN} [V]	V _{CC,MAX} [V]	I _{CC,TYP} [uA]	V _T (S version) [mV rms]	V _T (A version) [mV rms]	V _{SCON} [V]	t _{ON} [ms]	PKG
GL7101	12	20	400	11.50 ~ 13.86	13.86 ~ 15.60	0.7 ~ 1.4	1 ~ 4	SOP-8/ DIP-8

PRODUCTS

Driver - Precision Air-Core Tach/Speedo Driver

Device Name	Supply Voltage (Absolute) [V]	Max. Input Freq. Range [kHz]	Output V _{SAT} [V]	Output Voltage [V]	(V _{CCOS+} -V _{CCOS-}) [V]	(V _{SIN+} -V _{SIN-}) [V]	PKG
CS8190	24	20	0.15 @ I _{CC} =10mA	7	6.5 @ θ=0° -6.5 @ θ=180°	6.5 @ θ=90° -6.5 @ θ=270°	SOP-20

Driver - Quadruple Half-H Driver

Device Name	Max. Supply Voltage [V]	Logic Supply Voltage [V]	Max. Power Supply Current [mA]	Max. Logic Supply Current [mA]	Source Output Sat. Voltage [V]	Sink Output Sat. Voltage [V]	PKG
L293D	36	4.5 ~ 7	14	35	1.4	1.2	DIP-16

Logic IC

Device Name	V _{CC(MIN)} [V]	V _{CC(MAX)} [V]	CH. [#]	I _{OL(MAX)} [mA]	I _{OH(MAX)} [mA]	V _{OL(MAX)} @ V _{CC} =6V	V _{OH(MIN)} @ V _{CC} =6V	t _{PD,TYP} @ V _{CC} =4.5V	PKG
74HC00	2	6	4	5.2	-5.2	0.4V @ I _{OL,MAX}	5.2V @ I _{OH,MAX}	9 ns	SOP-14/ DIP-14
74HC04	2	6	6	5.2	-5.2	0.4V @ I _{OL,MAX}	5.2V @ I _{OH,MAX}	9 ns	SOP-14/ DIP-14
74HC14	2	6	6	5.2	-5.2	0.4V @ I _{OL,MAX}	5.2V @ I _{OH,MAX}	15 ns	SOP-14/ DIP-14
74HC595	2	6	1	5.2	-5.2	0.4V @ I _{OL,MAX}	5.2V @ I _{OH,MAX}	20 ns	TSSOP/SOP/ DIP-16

Device Name	V _{CC} [V]	CH. [#]	R _{ON,MAX} [ohm]	R _{ON,MAX} [ohm]	R _{ON,MAX} [ohm]	I _{IN} [uA]	I _{ON} [uA]	I _{OFF} [uA]	PKG
CD4066B	3 ~ 18	4	1050 @ 5V	400 @ 10V	240 @ 15V	±0.1	±0.1	±0.1	SOP-14/ DIP-14

Device Name	V _{CC(MIN)} [V]	V _{CC(MAX)} [V]	CH. [#]	I _{OL,MIN} [mA]	I _{OH,MIN} [mA]	V _{OL,MAX} @ V _{CC} =5V	V _{OH,MIN} @ V _{CC} =5V	t _{PD,TYP} @ V _{CC} =5V	PKG
CD4069UB	3	18	6	0.51	-1.6	0.05V	4.95V	110 ns	SOP-14/ DIP-14
CD4081B	3	18	4	0.51	-1.6	0.05V	4.95V	250 ns	SOP-14/ DIP-14
CD4093B	3	18	4	0.51	-1.6	0.05V	4.95V	380 ns	SOP-14/ DIP-14

TVS

Device Name	Lines	Reverse Stand-Off [V]	Min. Breakdown Voltage [V]	Max. Reverse Leak Current [A]	ESD Immunity Contact [kV]	ESD Immunity Air [kV]	PKG
SM05	2	5	6.0	5	8	15	SOT-23-3L
SRV05-4	4	5	5.8	5	8	15	SOT-23-6L

Timer

Device Name	V _{CC,MIN} [V]	V _{CC,MAX} [V]	F _{OSC,MAX} [kHz]	I _{CC,TYP} [uA]	I _{O,MAX} [mA]	V _{OL,MAX} @ V _{CC} =15V [V]	V _{OH,MIN} @ V _{CC} =15V [V]	PKG
NE555	2	18	500	300	20	1.0	14.3	SOP-8/ DIP-8

Non-Synchronous DC/DC Converter (Step-Down Switching Regulator)

Device Name	V _{OUT} [V]	V _{FB} [V]	V _{IN,MAX} [V]	I _{OUT,MAX} [A]	F _{SW} [kHz]	PKG
LM2574	ADJ/ 3.3/ 5.0/ 12	1.23	40	0.5	52	DIP-8/ SOP-14
LM2575	ADJ/ 3.3/ 5.0/ 12	1.230	40	1.0	52	SOP-8PP/ TO-263-5L/ TO-220-5L
LM2576	ADJ/ 3.3/ 5.0/ 12/ 15	1.230	40	3.0	52	SOP-8PP/ TO-263-5L/ TO-220-5L
LM2596	ADJ/ 3.3/ 5.0/ 12/ 15	1.230	40	3.0	150	SOP-8PP/ TO-263-5L/ TO-220-5L
LM2596G	ADJ/ 3.3/ 5.0/ 12/ 15	1.230	40	3.0	150	TO-263-5L
LM4576	ADJ/ 3.3/ 5.0/ 12/ 15	1.230	40	3.0	300	SOP-8PP/ TO-263-5L/ TO-220-5L
LM1501AG	ADJ/ 3.3/ 5.0/ 12	1.230	40	5.0	150	TO-263-5L/ TO-220-5L
LM1501BG	ADJ/ 3.3/ 5.0/ 12	1.230	40	5.0	300	TO-263-5L/ TO-220-5L

Step-Up Switching Voltage Regulator

Device Name	V _{IN} [V]	I _{SW} [A]	V _{SW,MAX} [V]	I _{CC} [uA]	F _{SW} [kHz]	PKG
LM1938	2.5 ~ 10	0.65	36 (Absolute)	0.1 (Shut-down) 2100 (Operating)	1300	SOT-23-6L

Products Under Development

CROSS REFERENCE GUIDE

Catalog	TAEJIN	TI	ON-SEMI	ST	MICROCHIP	ROHM	
High Performance Linear Power ICs	TPS761xx	TPS788xxDBVR, LP2985A-xxDBV, TPS761xxDBVR, TPS709xxDBVR		LD2981ABMxxTR, LD2985BMxxR, LD2980ABMxxTR, LDK220Mxx / 320Mxx	MIC5247-xxBM5, MIC5205-x.xYM5, MIC5235-3.3YM5		
	TPS73001	TPS73201DBVR, TPS73001DBVR, TPS79101DBVR	CAT6220TDI-GT3	LDLC015MR	MIC5318YD5, MIC5319		
	TPS730xx	LP5907MFX-x.x, LP5907SNX-x.x, TLV703xx, TLV702xx, TPS721xxDBVR	NCP115ASNxx, NCP4589DSQxx, NCP4589DSNxx		LDLN025PU/M.xx, LD39020DTPUxx, LD39030DTPUxxR, LD3985MxxR	MIC5323, MCP1711T-xxI/OT, MCP1711T-xxI/5X, MIC5247-xxBM5	BDxxTD3WG
	TPS740xx	TLV702xxDBVR, TLV740xxPDBVR, TLV757xxPDBVR, TPS735xx	CAT6219-xxxTDG, CAT6219ADJTD		MIC5319-x.xYD5	BUxxSD5	
	TPS1117LVxx	TLV1117LVxxDCYR, LM3940IMP-x.x			TC2117-x.xVDBTR, MIC37139-xxBS	BDxxIA5MEFJ-ME2	
	TPS7A8001	TPS7A8001DRB, TPS786xx	CAT6243DCADJ-RKG	LDL112	MIC37102	BDxxIC0WEFJ, BDxxKA5WF-E2	
	TPS7A7001	TPS796xxKTT, TPS7A7001DDA, TPS78630, LP3965	CAT6243DCADJ-RKG	LD39150	MIC37139		
	TPS7A7002	TPS7A7002DDA, TPS7A7002DDAR, TPS758xx, TPS74401, TPS75701KTT, LP38501-TS-ADJ	NCP4632DDTADJ	LD39300	MIC37302		
	TPS7A4501	TPS7A4501KTR	NCP59150DSADJ, NCV59150DSADJ, NCP57152DSADJ, NCV57152DSADJ				
	TPS75701	TPS75701KTT	NCP59302DSADJ, NCV59302DSADJ, NCP5663DSADJR4G, NCV5663DSADJR4G	LD29300P2MTR	MIC39302WU, MIC29302WU		
	TPS75501	TPS75501KTT			MIC29502WU		
	TPS2553D	TPS2553DBVR	NCP380H5NAJ		MIC2009YM6, MIC2019YM6	BD2242G	
	LP2998	LP2998	NCP51198		MIC5166		
Dual Channel CMOS ULDO Voltage Regulator (MLCC)	LM2C1117						
	TJ5641/H						
60V Operative Non-Synchronous DC/DC Converter	LM2575HVDP-x.x	LM2574HVM-xx, LM2574HVN-xx, TL2575HV-xxIN		L4971, L4976			
	LM2575HVR-x.x	LM2575HVS-x.x, TL2575HV-xxIKTT					
	LM2575HVT-x.x	LM2575HVT-x.x, TL2575HV-xxIKV					
	LM2576HVDP-x.x						

CROSS REFERENCE GUIDE

Catalog	TAEJIN	TI	ON-SEMI	ST	MICROCHIP	ROHM
60V Operative Non-Synchronous DC/DC Converter	LM2576HVR-x.x	LM2576HVS-x.x				
	LM2576HVT-x.x	LM2576HVT-x.x				
	LM2596HVGP-x.x	LM2594HVMX-x.x, LM2594HVN-x.x		L7987L, L4973		
	LM2596HVGR-x.x	LM2591HVS-x.x, LM2592HVS-x.x, LM2593HVS-x.x				
	LM2596HVGT-x.x	LM2591HVT-x.x, LM2592HVT-x.x, LM2593HVT-x.x				
CMOS ULDO Voltage Regulator (MLCC)	TJ9198	LP5907MFX-x.x, LP5907SNX-x.x, TLV703xx, TLV702xx, TPS721xxDBVR	NCP115ASNxx, NCP4589DSQxx, NCP4589DSNxx	LDLN025PU/M.xx, LD39020DTPUxx, LD39030DTPUxxR, LD3985MxxR	MIC5323, MCP1711T-xxI/OT, MCP1711T-xxI/5X, MIC5247-xxBM5	BDxxTD3WG
	TJ4303GSF5-x.x	TPS73201DBVR, TPS73001DBVR, TPS79101DBVR	CAT6220TDI-GT3	LDLC015MR	MIC5318YD5, MIC5319	
	LM1108					
	LM8805SF5-x.x	TLV702xxDBVR, TLV757xxPDBVR, TPS735xx	CAT6219-xxxTDG, CAT6219ADJTD		MIC5319-x.xYD5	BUxxSD5
	TJ1119C/FGS-x.x	TLV1117LVxxDCYR, LM3940IMP-x.x			TC2117-x.xVDBTR, MIC37139-xxBS	BDxxIA5MEFJ-ME2
	TJ1119C/FGRS-x.x					
	TJ1801			LDL112		
	TJ4310 Series	TPS786xx	AT6243DCADJ-RKG	LDL112	MIC37102	BDxxIC0WEFJ, BDxxKA5WF-E2
	LD39150/ADJ			LD39150PT, LD39150DTxx, LD39150PU	MIC39150, MIC39152WD	
	TJ2132 Series			LD49150		
	TJ4320 Series	TPS796xxKTT, TPS78630, LP3965	AT6243DCADJ-RKG	LD39150	MIC37139	
	TJ4330 Series	TPS758xx, TPS74401, TPS75701KTT, LP38501-TS-ADJ	NCP4632DDTADJ	LD39300	MIC37302	
	TPS7A7002DP	TPS7A7002DDA, TPS7A7002DDAR			MIC37302WR	
TJ2134/AGDP	TPS7A85		LD49300PTxx			

CROSS REFERENCE GUIDE

Catalog	TAEJIN	TI	ON-SEMI	ST	MICROCHIP	ROHM
OCP IC	TJ2242GSF6	TPS2553DBVR	NCP380HSNAJ		MIC2009YM6, MIC2019YM6	BD2242G
	TJ2242AGSF6	TPS2553DBVR	NCP380HSNAJ		MIC2009YM6, MIC2019YM6	BD2242G
	TJ82034HGD	LM3525M				BD82034
Sink / Source Linear Regulator	TJ2998GD	LP2998	NCP51198		MIC5166	
	TJ2998GDP	LP2998	NCP51198		MIC5166	
VLDO Voltage Regulator	LM2950/1D-x.x	LP295x	LP295x, NCV4264D50R2G		MIC295x	
	TJ2950G/GTF5-x.x	LP2950ACZ-x.x	LP2950ACZ-x.x		MIC2950	
	TJ5205 Series	LP2985 Series, TPS788xxDBVR, TPS761xxDBVR, TPS709xxDBVR,		LD2981ABMxxTR LD2985BMxxR, LD2980ABMxxTR, LDK220Mxx / 320Mxx	MIC5247-xxBM5, MIC5205-x.xYM5, MIC5235-3.3YM5	
	LP2985SF5-x.x	LP2985 Series, TPS788xxDBVR, TPS761xxDBVR, TPS709xxDBVR,		LD2981ABMxxTR LD2985BMxxR, LD2980ABMxxTR, LDK220Mxx / 320Mxx	MIC5247-xxBM5, MIC5205-x.xYM5, MIC5235-3.3YM5	
	LM9076D	LM9076BMA/BMX-x.x				
	LM9076R	LM9076S/SX-x.x				
	TJ62FPxxGSF/GF				MCP1702T-xx02E/MB	
	TJ75xxG/GF		MC78LC5xxHT1G	LDK320ADUxxR	MCP1701AT-xx, MCP1702/T	
	LM2954	LP2954				BD3650FP-M
	LM2940S	LM2940IMP-x.x, LM2940CS/CT-x.x			MIC2940A-x.xWT/WU, MIC2941AWT/WU	
	LM2940T	LM2940CT-x.x, LM2940CS-x.x			MIC2940A-x.xWT/WU, MIC2941AWT/WU	BA033CC0T, BA05CC0T
	LM2940HD					
	LM2940HR	LM2940S-x.x, LM2940IMP/CT-x.x			MIC2940A-x.xWT/WU, MIC2941AWU / WT	
	LM2940HT	LM2940CT-x.x, LM2940IMP/CS/LD-x.x			MIC2940A-x.xWT / WU, MIC2941AWT / WU	
	LM37100S-x.x			LD29080SxxR	MIC39100-x.xWS, MIC37100-x.xWS	
	LM37101D-x.x	UCC381DP-x, UCC281DP-x.	MC33269DR2-x.xG		MIC39101-x.xYM, MIC37101-x.xYM	
	LM37102D	TL5209DR, UCC381DP-xADJ UCC281DP-ADJ	MC33269DR2G		MIC39102YM, MIC37102YM	
	LM37102RS		NCP5661DTADJRKG	LD29080PT	MIC37102BR	BA00BC0WFP
	LM37102CGD/GDP	TL5209DR, TPS73801DCQR	MC33269DR2G		MIC39102BM, MIC37102BM	
	LM39100S-x.x			LD29080Sxx	MIC39100-x.xBS, MIC37100-x.xBS	
	LM39100RS-x.x			LD29080DTxx, LDFxxDT, LD39080DTxx		BAxxBC0FP
	LM39101D-x.x	UCC381DP-x, UCC281DP-x.	MC33269DR2-x.xG		MIC39101-x.xYM, MIC37101-x.xYM	
	LM39101RS-x.x			LDFxxPT		BAxxBC0WFP, BA00BC0WFP]

CROSS REFERENCE GUIDE

Catalog	TAEJIN	TI	ON-SEMI	ST	MICROCHIP	ROHM
VLDO Voltage Regulator	LM39102D	TL5209DR, TPS73801DCQR, UCC381DP-xADJ UCC281DP-ADJ	MC33269DR2G		MIC39102YM, MIC37102YM	
	LM39102RS		NCP5661DTADJRKG	LDFPT, LD29080PTR	MIC37102BR	BA00BC0WFP
	LM29150RS-x.x			LD29150DTxxR, LD39150DTxx, LFxxAB/CDT		BDxxFC0FP-E2
	LM29150R-x.x	LM2940S-xx, LM2940CS-xx	NCP59150DSxx, NCV59150DSxx, NCP565D2Txx, NCV565D2Txx,		MIC29150-x.xWU	BAxxDD0WHFP
	LM29150T-x.x	LM2940T-xx LM2940CT-xx		LFxxAB/CV, LFxxAB/CV-DG	MIC29150-x.xWT	BAxxJC5T
	LM29151R-x.x	TPS7A45xxKTTR	NCP59150DSxx, NCV59150DSxx, NCP565D2Txx, NCV565D2Txx		MIC29151-x.xWU	
	LM29152RS			LD29150PTR LD39150PTxx, LFxxAB/CPT	MIC29152WD	BA00CC0WFP, BD00FC0WFP-E2
	LM29152R	TPS7A4501KTTR	NCP59152DSADJ, NCV59152DSADJ, NCP57152DSADJ, NCV57152DSADJ			
	LM29152T				MIC29152WT	BA00CC0WT, BA00JC5WT
	LM39300R-x.x		NCP59300DSxx, NCV59300DSxx, NCP5663DSxxR4G, NCV5663DSxxR4G	LD39300DTxx	MIC39300-x.xBU	
	LM39300T-x.x				MIC39300-x.xBT	
	LM39301R-x.x	TPS757xxKTT, LP3853/6ES-x.x	NCP59301DSxx, NCV59301DSxx	LD39300PTxx	MIC39301-x.xBU	BAxxDD0WHFP
	LM39301T-x.x	TPS757xxKC, LP3853/6ET-x.x			MIC39301-x.xBUT	
	LM39302R	TPS75701KTT	NCP59302DSADJ, NCV59302DSADJ, NCP5663DSADJR4G, NCV5663DSADJR4G	LD29300P2MTR	MIC39302WU, MIC29302WU	
	LM39302T	TPS75701KC			MIC39302WU	
	LM29300R-x.x				MIC29300-x.xWU	
	LM29300T-x.x				MIC29300-x.xWT	
	LM29301R-x.x				MIC29301-x.xWU	
	LM29301T-x.x				MIC29301-x.xWT	
	LM29302R				MIC29302WU	
	LM29302T				MIC29302WT	
	LM39502R	TPS75501KTT			MIC29502WU	
	LM39502T	TPS75501KC			MIC29502WT	

CROSS REFERENCE GUIDE

Catalog	TAEJIN	TI	ON-SEMI	ST	MICROCHIP	ROHM
LDO Voltage Regulator	LM1117S-x.x	REG1117/A-x.x, LM1117MP-x.x, LMS8117AMP-x.x	NCP1117STxxT3G, MC33269ST-x.x	LD1117SxxTR		
	LM1117F-x.x					
	LM1117RS-x.x	LM1117DT-x.x, LMS8117ADT-x.x	NCP1117DTxx, NCV1117DTxx, MC33269SDT-x.x	LD1117DTxxTR		BA1117FP-E2
	LM1117GS-x.x	REG1117/A-x.x, LM1117MP-x.x, LMS8117AMP-x.x	NCP1117STxx, NCV1117STxx, MC33269ST-x.x, NCV565STxx	LD1117SxxTR, LDL1117xxR		
	LM1086R/RS-x.x	LM1086		LD1086		
	LM1085R/RS-x.x	LMS1587IS/CS-x.x, LMS1587IT/CT-x.x, LM1085		LD1085		
	LM1084R/RS-x.x	LMS1585IS/CS-x.x, LMS1585IT/CT-x.x, LM1084	CS5205-1GDP	LD1084		
Standard Linear Voltage Regulator	LM78L05/F/D	UA78Lxx, LM78Lxx	MC78Lxx, KA78Lxx, LM78Lxx, NCV78L05ABDR2G	L78Lxx		BDxxFA1FP3
	TJ78L05GF	UA78Lxx, LM78Lxx	MC78Lxx, KA78Lxx, LM78Lxx	L78Lxx		BDxxFA1FP3
	LM78Lxx/F	UA78Lxx, LM78Lxx	MC78Lxx, KA78Lxx, LM78Lxx	L78Lxx		BDxxFA1FP3
	LM79Lxx/F	LM79Lxx	MC79Lxx	L79Lxx		
	LM317L/LF/LD	TL317, LM317L	LM317L	LM317L		
	LM78MxxRS	LM78Mxx	MC78Mxx, KA78Mxx	L78MxxCP, L78MxxACV		BA78MxxFP
	LM79MxxTP	LM79MxxCT, UA79MxxCKCS	MC79MxxBT/CT, KA79Mxx	L79MxxCP, L79MxxACV, L79MxxACV-DG		
	LM317	LM317, LM317A	LM317, LM317B, NCV317	LM317, LM217, LM117		
	LM78xx	LM78xx	MC78xx, KA78xx	L78xxCP, L78xxACP		BA78xxFP
	LM79xx	LM79xxCT, UA79xxCKCS	MC79xxBT/CT, KA79xx	L79xxCP, L79xxACV, L79xxACV-DG		
Interface IC	MAX232EN	MAX232N/IN		ST232CN		
	MAX3232D	TPS3232ECPWR, MAX3232				
	MAX485ED	SN75176AD, DS1487M, ADM485AR		ST485BDR, ST485CDR		
	MAX485EN	SN75176AP, DS1487N, ADM485AN		ST485BN, ST485CN		
	MAX3485ED	SN65HVD11D/DR, SN75HVD12D/DR		ST1480ABDR, ST3485EBDR		

CROSS REFERENCE GUIDE

Catalog	TAEJIN	TI	ON-SEMI	ST	MICROCHIP	ROHM
Converter & Controller	MC34063AD	MC34063AD,	MC34063ADG, SC34063ADR2G, NCP3066DR	MC34063ACD-TR, MC34063ECD-TR		
	MC34063AGN	MC34063AP	MC34063AP1G, SC34063AP1G, NCP3066PG	MC34063ACN, MC34063ECN		
	MC34063BD	MC33063AD	MC33063ADG, SC33063ADR2G, NCP3066DR	MC34063ABD-TR		
	MC34063CD	MC33063AD, MC34063AD	MC33063ADG, SC33063ADR2G, NCP3066DR	MC34063ABD-TR		
	TJ34063AGD	MC33063AD, MC34063AD	MC34063ADG, MC33063ADG, SC33063ADR2G	MC34063ABD-TR		
	TJ34063CGD	MC33063AD, MC34063AD	MC33063ADG, SC33063ADR2G	MC34063ABD-TR		
	LM3842AD	UC3842D, TL3842BDR-8	UC3842AD / BD	UC3842BD, UC3844BD	MIC38C42BM	
	LM3842AN	UC3842N, TL3842BP	UC3842AN / BN	UC3842BN, UC3844BN	MIC38C42BN	
	LM3843AD	UC3843D, TL3843BDR-8	UC3843AD / BD	UC3843BD, UC3845BD	MIC38C43BM	
	LM3843AN	UC3843N, TL3843BP	UC3843AN / BN	UC3843BN, UC3845BN	MIC38C43BN	
	TL494D	TL494CD, TL494ID	TL494CD			
	TL494N	TL494CN, TL494IN	TL494CN, TL494IN			
	TJ9910GD		CS5171, NCV5171EDR2G, CS5173		MIC2172	
	TJ9910AGD				HV9910BLG-G, HV9861ALG-G	
	TJ33120GD				HV9910BLG-G, HV9861ALG-G	
TJ7660D	LM2660MX	CAT660EVA-GT3				
TJ7660N	TL7660CP					
TJ1051						
Comparator	TJ393GD	LM293D, LM393D, LM2903D	LM293D, LM393D, LM2903D	LM393D		LM393D, BA10393F
	TJ393GN	LM293P, LM393P, LM2903P	LM293N, LM393N, LM2903N	LM393		LM393, BA10393
	LM393GN	LM293P, LM393P, LM2903P	LM293N, LM393N, LM2903N	LM393		LM393, BA10393
	TJ339GD	LM339	LM239, LM339, MC3302	LM339		LM339, BA10339
	LM339GD	LM339	LM239, LM339, MC3302	LM339		LM339, BA10339
	LM339N	LM339	LM239, LM339, MC3302	LM339		LM339, BA10339

CROSS REFERENCE GUIDE

Catalog	TAEJIN	TI	ON-SEMI	ST	MICROCHIP	ROHM
Operational Amplifier	LM358N	LM358N, LM258P	LM258N, LM358N, KA358, KA2904	LM258N		
	TJ358GD	LM258, LM358	LM258, LM358, KA258D, KA358D	LM358		LM358, BA10358
	TJ358GTD	LM358APW		LM358PT		LM358PT
	LM2904D	LM2904D	LM2904D, KA358D	LM2904DT, LM358		LM358, BA10358
	LM4558D	RC4558, RC4558I		MC4558CD		BA4558Y
	TJ4558GD	RC4558, RC4558I		MC4558CD		BA4558Y
	TJ324GD	LM224, LM324	LM224, LM324	LM324		LM324, BA10324A
	LM324N	LM224, LM324	LM224, LM324	LM324		LM324, BA10324A
	LM2902	LM224, LM324	LM224, LM324	LM324		LM324, BA10324A
	OP07CD	OP07CD, OP07DD OP07CPS, OP07DPS				
	OP07CN	OP07CP, OP07DP OP07CPS, OP07DPS		OP07C, OP07CN		
	LM386D	LM386M, LM386MX,				
Darlington Transistor Array	ULN2003AD	ULN2003ADxxx, ULQ2003ADxx	ULN2003ADR2G, ULQ2003ADR2G	ULN2003DD1013TR		BA12003DF-Z
	ULN2003AN	ULN2003AN ULQ2003AN		ULN2003A		
	ULN2803AD	ULN2803ADWxx				
	ULN2803AN	ULN2803AN	ULN2803A	ULN2803A		
	ULN62783AD					
Driver	CS8190N		CS8190ENF16G CS4121ENF16			
	L293DN	L293DNE, L293NE		L293D, L293DD		
Voltage Reference	TL431x	TL431/2, TL1431	TL431, LM431	TL431x, TL432		
	TJ431x	TL431/2	TL431, LM431	TL432		
	LP431GxSF	ATL432	NCP431			
	LM431xSF	TL431, LM431		TL1431, TL431		
	TJR431xSF	TL431, LM431		TL1431, TL431		
	LPR431GxSF	ATL431	NCP432			
	TL432x	TLV431, LMV431, TLVH431	TLV431	TS432, TLVH431		
	LM336	LM336Z/BZ-x.x, LM136Z/BZ-2.5, LM236Z/BZ-2.5	LM336Z25, LM336Z5X	LM336Z, BZ, LM236Z		
	LM336D	LM336M, BM-x.x, LM136M, BM-x.x, LM236M, BM-x.x,		LM336D / DT, BD / BDT, LM236D/DT		
	LM385	LM385Z/BZ/BXZ/BYZ LM185Z/BZ/BXZ/BYZ LM285Z/BZ/BXZ/BYZ	LM385Z/BZ-x.x, LM185Z/BZ-x.x, LM285Z/BZ-x.x,			
	LM385D	LM385M/BM/BMX/BD LM185M/BM/ BMX, LM285M/BM/BMX,	LM385D/BD-x.x, LM185D/BD-x.x, LM285D/BD-x.x,			

CROSS REFERENCE GUIDE

Catalog	TAEJIN	TI	ON-SEMI	ST	MICROCHIP	ROHM
Logic IC	74HC00D	SN74HC00D SN74HC00DB/NS/PW	74HC00DR2G, 74HC00DTR2G	M74HC00M1R / RM13TR, M74HC00TTR		
	74HC00N	SN74HC00N SN74HC00DB/NS/PW	74HC00DTR2G	M74HC00B1R, M74HC00TTR		
	74HC04D	SN74HC04D SN74HC04DB/NS/PW	74HC04DR2G, 74HC04DTR2G	M74HC04RM13R, M74HC04YRM13TR,		
	74HC04N	SN74HC04N SN74HC04DB/NS/PW	74HC04DTR2G	M74HC04B1R, M74HC04TTR/YTTR		
	74HC14D	SN74HC14D SN74HC14DB/NS/PW	74HC14DR2G, 74HC14DTR2G	M74HC14YRM13TR, M74HC04YTTR		
	74HC14N	SN74HC14N SN74HC14DB/NS/PW	74HC14DTR2G	M74HC04YTTR		
	CD4066BD	CD4066BM/BM96/BM96E4/BM96G4	MC14016BDG/BDR2G, NMV14016BDR2G, 74HC4066ADR2G	M74HC4066M1R		BU4066BCF
	CD4066BN	CD4066BE/BEE4		M74HC4066B1R		BU4066BC
	TVS-Array	SM05SF	TPD2E2U06	MMBZ6V8ALT1G	ESDA6V1L	
SRV05-4SF6		TPD4E001DBVR	CM1224-04SO	ESDA6V1-5SC6		
Timer	NE555D	NE555DX, LM555CM, SE / NA / SA555DX	LM555CM/CMX	NE555D/DT, SA555D/DT, SE555D/DT		
	NE555N	NE555P, LM555CN, SE/NA/SA555P	LM555CN	NE555N, SA555N, SE555N		
Non-Synchronous DC/DC Converter	LM2575GDP-x.x	LM2574M-xx, LM2574N-xx, TL2575-xxIN, LM2575IN	LM2574DW-xx, LM2574N-xx, LM2575T-x.x, LM2575TV-x.x,	L6902D, A5970AD, L5970AD	LM2574-x.xXN, LM2575-x.xBN, / BWM / YN / YWM m MCP16301/H	BD90610EFJ-C
	LM2575GR-x.x	TL2575-xxIKTT, LM2575S-x.x, LM1575S-x.x, LM2595S-x.x	LM2575D2T-x.x NCV2575D2T-xx		LM2575-x.xBU/WU, MIC4575-x.xBU	
	LM2575GT-x.x	TL2575-xxIKV, LM2575T-x.x, LM1575T-x.x, LM2595T-x.x	LM2575T-x.x, LM2575TV-x.x,		LM2575-x.xBT/WT, MIC4575-x.xBT	
	LM2576DP-x.x			L5972D	MIC4684BM/YM	BD9G401EFJ-M, BD90620EFJ-C
	LM2576R-x.x	LM2576S-x.x	LM2576D2T-x.x		LM2576-x.xBU/WU, MIC4576-x.xBU,	
	LM2576T-x.x	LM2576T-x.x,	LM2576T-x.x		LM2576-x.xBT/WT, MIC4576-x.xBT	
	LM2596DP-x.x	LM2594MX-x.x, LM2594N-x.x	LM2594D/PADJ	A5975D, L5987, L5973D		
	LM2596R-x.x	LM2596S-x.x, LM2595S-x.x,	LM2596DSADJG, LM2595DSADJG,		MIC4576-x.xBU	BD9701/2
	LM2596T-x.x	LM2596T-x.x, LM2595T-x.x,	LM2596TADJG, LM2595TADJG		MIC4576-x.xBT	BD9701/2
	LM2596GDP-x.x	LM2591HVT-x.x, LM2592HVT-x.x, LM2593HVT-x.x,				
	LM2596GR-x.x			L5973D		
	LM2596GT-x.x	LM2596R-x.x	LM2596DSADJG		MIC4576-x.xBU	BD9701/2
LM4576	LM2596T-x.x	LM2596TADJG		MIC4576-x.xBT	BD9701/2	
LM1501A/B	LM2596 LM2675-x.x LM22678-x.x, LM2678D/S/T-x.x	LM2596	A5975D, A7986A L5973D, L4976	MIC4576 MIC4684BM, MIC4680	BD9701/2, BD9G401EFJ-M BD90640EFJ-C	
Step-Up DC/DC Converter	LM1937SF5	LM22678-x.x, LM2678D/S/T-x.x				BD90640EFJ-C
	LM1938SF6	TPS61041, LM27313, TPS61165			MIC2287	