

AEDR-8320 Encoder

Reflective Surface Mount Optical Encoder

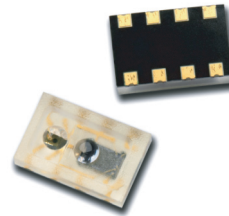

Data Sheet



Description

The AEDR-8320 encoder is an analog output encoder that employs optical reflective technology for rotary and linear movement control.

With the introduction of reflective technology, encoder packages can now be made smaller and weigh significantly lighter. This statement is better reflected in the ability of the AEDR-8320 encoder which can easily fit into many space and weight constraint applications, e.g., CD or DVD writer laser head's linear movement.

The AEDR-8320 comes in a 180 LPI (Lines Per Inch) or 7.09mm lines per mm. In addition its 2-channel analog outputs can obtain higher resolution through interpolation of 2x, 4x, 8x or more. For example, with 8x interpolation, the final resolution of the encoder will yield 1,440 lines per inch, which is approximately 20 μm accuracy.

AEDR-8320 encoder enhances design flexibility and provides an easy-to-assemble solution to a wide variety of applications, while continuously ensuring reliability in performance.

Features

- Reflective technology
- Surface mount leadless package
- Two-channel analog voltage output
- Lead free package
- -10°C to 70°C operating temperature
- Encoding resolution:
180 (lines/inch) or 7.09 (lines/mm)

Applications

- Printers
- Copiers
- CD/DVD writer
- Card readers

Theory of Operation

The AEDR-8320 encoder combines an emitter and a detector in a single surface mount, leadless package. When used with a codewheel or linear codestrip, the encoder translates rotary or linear motion into analog outputs. As shown in the block diagram below, the AEDR-8320 encoder consists of three major components: a light emitting diode (LED) light source, a detector IC consisting photodiodes and lens to focus light beam from the emitter as well as light falling on the detector.

The operation of the encoder is based on the principle of optics where the detector photodiodes sense the absence and presence of light. In this case, the rotary/linear motion of an object being monitored is converted to equivalent light pattern via the use of codewheel/codestrip. As shown in the above diagram, the reflective area (window) of the codewheel (or codestrip) reflects light back to the photodetector IC, whereas no light is reflected by the non-reflective area (bar). An alternating light and dark patterns corresponding to the window and bar fall on the photodiodes as the codewheel rotates. The moving light pattern is exploited by the detector circuitry to produce analog outputs representing the rotation of the codewheel. When the codewheel is coupled to a motor the encoder outputs are then a direct representation of the motor rotation. The same concept applies to the use of a codestrip to detect linear motion.

Block Diagram of AEDR-8320

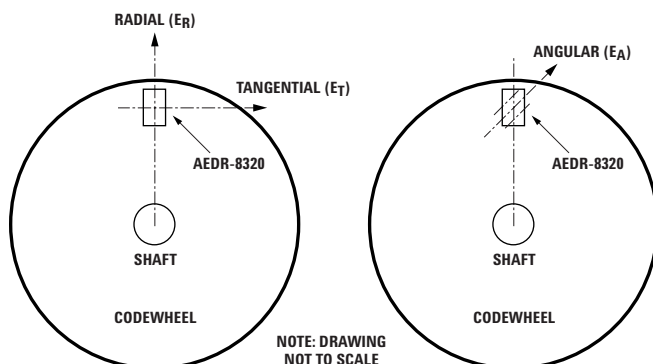
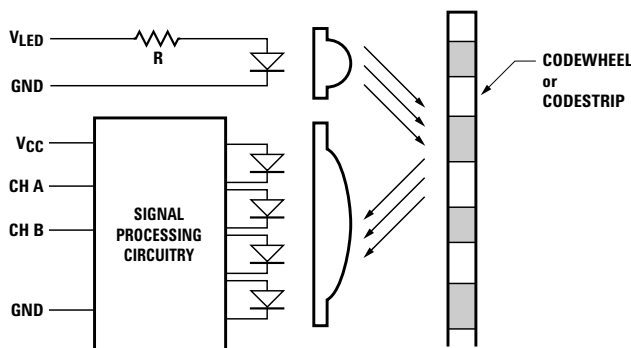

Definitions

State Width (S): The number of electrical degrees between a transition in Channel A and the neighboring transition in Channel B. There are 4 states per cycle, each nominally 90°e.

State Width Error (ΔS): The deviation of state width, in electrical degree, from its ideal value of 90°e.

Phase (ϕ): The number of electrical degrees between the center of high state of Channel A and the center of high state of Channel B. Nominally 90°e.

Phase Error ($\Delta\phi$): The deviation of phase, in electrical degree, from its ideal value of 90°e.

Pulse Width (P): The duration of high state of the output, in electrical degree, within one cycle. Nominally 180°e or half a cycle.

Pulse Width Error (ΔP): The deviation of pulse width, in electrical degree, from its ideal value of 180°e.

Count (N): The number of window and bar pair per revolution (CPR) of codewheel. For linear codestrip, defined as the number of window and bar pair per unit length (lines per inch [LPI] or lines per mm [LPmm]).

One Cycle (C): 360 electrical degrees (°e). Equivalent to one window and bar pair.

One Shaft Rotation: 360 mechanical degrees. Also equivalent to N counts (codewheel only).

Line Density: The number of window and bar pair per unit length, expressed in either lines per inch (LPI) or lines per mm (LPmm).

Optical radius (Rop): The distance between the codewheel center and the centerline between the two domes of the encoder.

Gap (G): The distance from surface of the encoder to the surface of codewheel or codestrip.

Radial and Tangential Misalignment Error (E_R , E_T): For rotary motion, mechanical displacement in the radial and tangential directions relative to the nominal alignment.

Angular Misalignment Error (E_A): Angular displacement of the encoder relative to the tangential line.

Specular Reflectance (R_f): The amount of incident light reflected by a surface. Quantified in terms of the percentage of incident light. A spectrometer can be used to measure specular reflectance of a surface (contact factory for more information).

Output Waveform

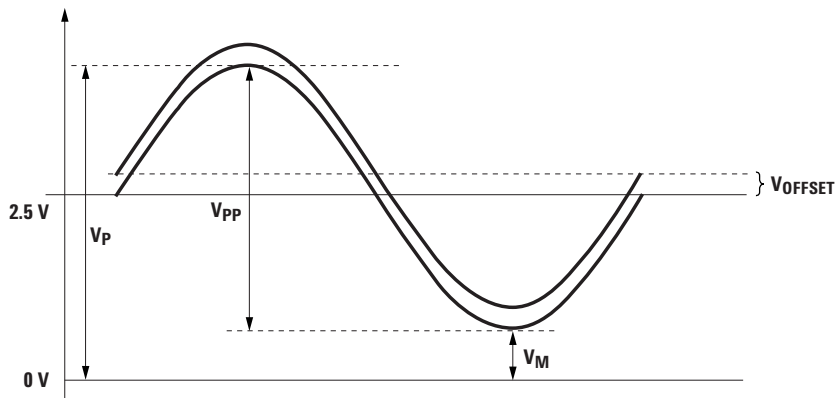
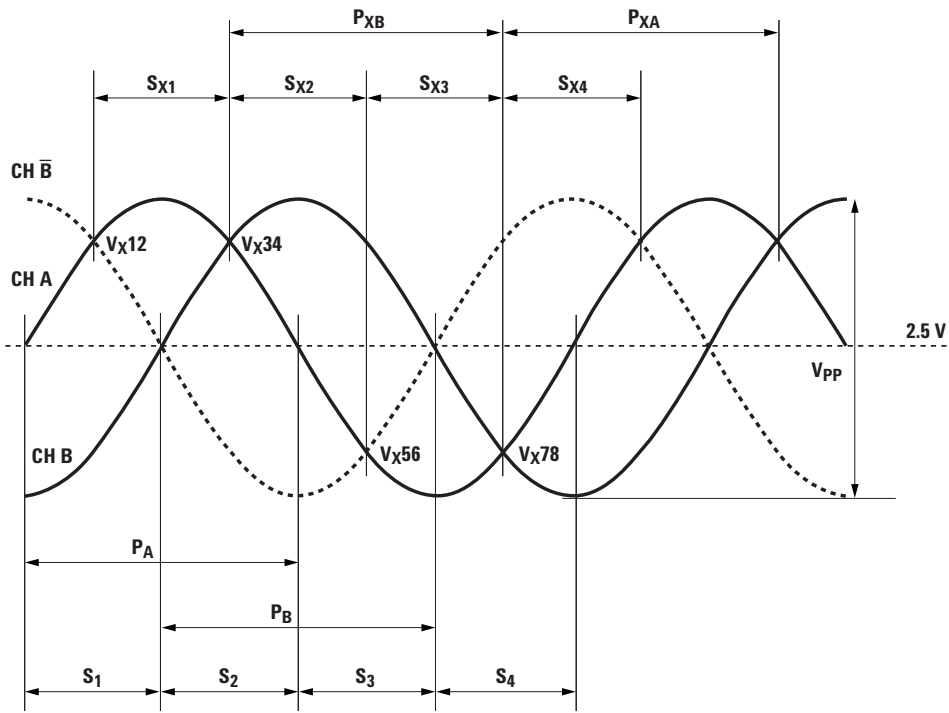

Test Parameter Definitions

Name	Symbol	Definition
State Width	S_1, S_2, S_3, S_4	The number of electrical degrees between a transition in channel A and the neighboring transition in channel B. There are 4 states per cycle, each nominally 90°e. The transitions are determined by where the analog signal crosses the 2.5V voltage level.
State Width Error	$\Delta S_1, \Delta S_2, \Delta S_3, \Delta S_4$	The deviation, in electrical degrees, of each state width from its ideal value of 90°e.
Pulse Width	P_A, P_B	The number of electrical degrees that an analog output is greater than 2.5V during one cycle. This value is nominally 180°e or 1/2 cycle.
Pulse Width Error	$\Delta P_A, \Delta P_B$	The deviation, in electrical degrees, of each pulse width from its ideal value of 180°e.
State X Width	SX_1, SX_2, SX_3, SX_4	The number of electrical degrees between a transition in channel A and neighboring transition in channel B. There are 4 states per cycle, each nominally 90°e. The transitions are determined by where the channel A analog signal crosses with channel B (or its complimentary) signal.
State X Width Error	$\Delta SX_1, \Delta SX_2, \Delta SX_3, \Delta SX_4$	The deviation, in electrical degrees of each state X width from its ideal value of 90°e.
Pulse X Width	P_{XA}, P_{XB}	Pulse X width A is the number of electrical degrees that analog A output is greater than analog B output during one cycle. Pulse X width B is the number of electrical degrees that analog B output is greater than analog A during one cycle. These value are nominally 180°e or 1/2 cycle.
Pulse X Width Error	$\Delta P_{XA}, \Delta P_{XB}$	The deviation, in electrical degrees of each pulse X width from its ideal value of 180°e.
Analog Peak-to-Peak	V_{PP}	The peak-to-peak signal magnitude in V of the analog signal.
Analog Offset	V_{OFFSET}	The offset in mV from the mid-point of the analog peak-to-peak signal to the zero voltage point.
Analog Peak Voltage	$V_{PA}, V_{PB}, V_{MA}, V_{MB}$	The value in V of the peak and valley of the analog signal (i.e., one-sided reading).
Analog Peak to Peak Voltage	V_{PPA}, V_{PPB}	The absolute difference between V_P and V_M of channel A or B.
Analog Crosspoint Voltage	$V_{x12}, V_{x34}, V_{x56}, V_{x78}$	The intersections in V of channel A analog waveform with that of either channel B or its component.
Analog Offset Voltage	$V_{OFFSETA}, V_{OFFSETB}$	The offset in mV from the mid-point of the analog peak to peak signal to 2.5V.
Linearity Error	$\Delta Linearity$	Ration (in percentage) of maximum voltage deviation from a straight line connecting adjacent upper and lower crosspoint voltages to the difference between crosspoint voltages.

Absolute Maximum Ratings

Parameter	Symbol	Min.	Max.	Units	Notes
Storage Temperature	T _S	-40	85	°C	
Operating Temperature	T _A	-10	70	°C	
Supply Voltage (Detector)	V _{CC}	-0.5	7	V	
Output Voltage	V _a , V _b	-0.5	V _{CC} + 0.4	V	
DC Forward Current (LED)	I _{LED}		40	mA	V _F < 3V
Reverse Voltage	V _R		5	V	I _R = 100 μA

Note:

1. Exposure to extreme light intensity (such as from flashbulbs or spotlights) may cause permanent damage to the device.
2. CAUTION: It is advised that normal static precautions should be taken when handling the encoder in order to avoid damage and/or degradation induced by ESD.

Recommended Operating Conditions

Parameter	Symbol	Min.	Typ.	Max.	Units	Notes
Operating Temperature	T	-10	25	70	°C	
Supply Voltage (Detector)	V _{CC}	4.75	5.0	5.25	V	Ripple < 100mV V _{pp}
Output Frequency	F	NA	5	20	kHz	(Velocity (rpm) x N)/60
DC Forward Current (LED)	I _{LED}	16	20	30	mA	See note 1

Note:

1. LED Current Limiting Resistor
A resistor to limit current to the LED is required.
For 3.3 V LED Supply Voltage: The recommended value series resistor is 47 Ω (±10%).
For 5.0 V LED Supply Voltage: The recommended resistor value will be 110 Ω (±10%).
This will result in an LED current of approximately 20 mA.

Electrical Characteristics

Characteristics over recommended operating conditions at 25°C.

Parameter	Symbol	Min.	Typical	Max.	Units	Notes
Supply Current (Detector)	I _{CC}	NA	5	8	mA	
LED Forward Voltage	V _F	NA	2.6	3.0	V	I _F = 20 mA typical

Encoding Characteristics

Encoding characteristics over the recommended operating condition and mounting conditions.

Parameter	Symbol	Max.	Unit
State Width Error	ΔS	± 40	$^{\circ}e$
Pulse Width Error	ΔP	± 40	$^{\circ}e$
State X Width Error	ΔS_X	± 40	$^{\circ}e$
Pulse X Width Error	ΔP_X	± 40	$^{\circ}e$

Parameter	Symbol	Min.	Typ.	Max.	Unit
Peak to Peak Voltage (Average)	V_{PPA}, V_{PPB}	0.8	1.5	3.0	V
Analog Offset Voltage	$V_{OFFSETA}, V_{OFFSETB}$	-350	NA	350	mV
Linearity Error	$\Delta Linearity$	NA	5.0	12.5	%

Note: Typical values represent the encoder performance at typical mounting alignment, whereas the maximum values represent the encoder performance across the range of recommended mounting tolerance.

Part Mounting Tolerances

	Min.	Typ.	Max.	Units
Radial Misalignment from Nominal	-0.2	0	0.2	mm
Tangential Misalignment from Nominal	-0.2	0	0.2	mm
Gap Distances Between Codewheel and Detector IC	0.8	1.5	2.0	mm
Angular Misalignment	-1	0	1	deg

Recommended Codewheel and Codestrip Characteristics

CODEWHEEL

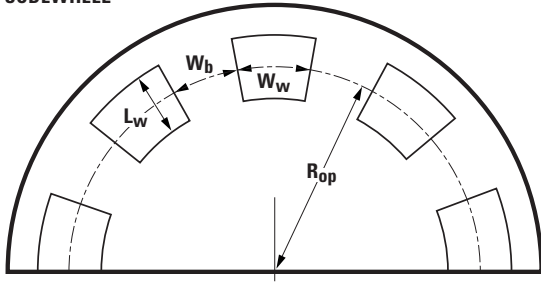

CODESTRIP

$$W_w = W_b = 70.5 \mu\text{m} \text{ (180 LPI)}$$

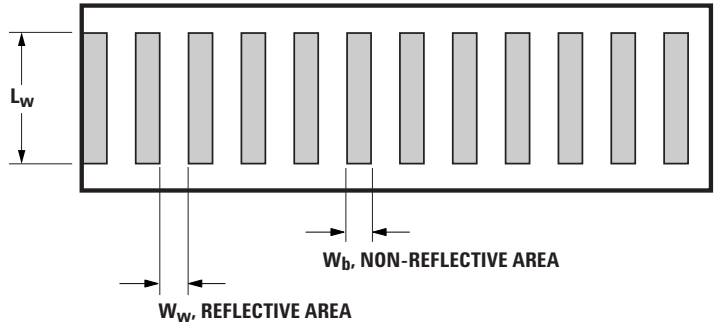

Parameter	Symbol	Min.	Max.	Unit	Notes
Window/Bar Ratio	W_w/W_b	0.9	1.1		
Window/Bar Length	L_w	1.80 (0.071)	2.31 (0.091)	mm (inches)	
Specular Reflectance	R_f	60	85		Reflective area. See note 1.
		–	10		Non reflective area
Line Density	LPmm (LPI)		7.09 (180)	lines/mm (lines/inch)	
Optical Radius	R_{op}		11	mm	Recommended value

Notes:

1. Measurements from TMA μ Scan meter. Contact factory for more information.
2. Contact factory for more information on compatibility of codewheel/strip.

Moisture Sensitive Level

The AEDR-8320 is specified to moisture sensitive level (MSL) 3.

Outline Drawing

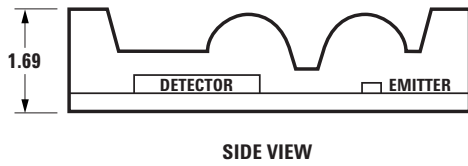
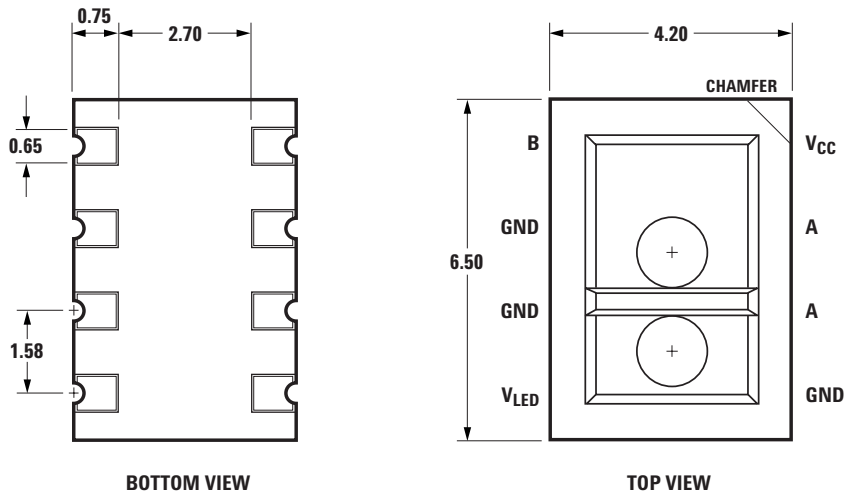

- NOTES:**
1. ALL DIMENSIONS IN MILLIMETERS.
 2. TOLERANCE X.XX \pm 0.15 mm.

Encoder Orientation

The AEDR-8320 is designed such that both the LED and detector IC should be placed parallel to the window/bar orientation, as shown. As such, the encoder is tolerant against radial play of ± 0.20 mm. The emitter side should be placed closer to the rotating shaft.

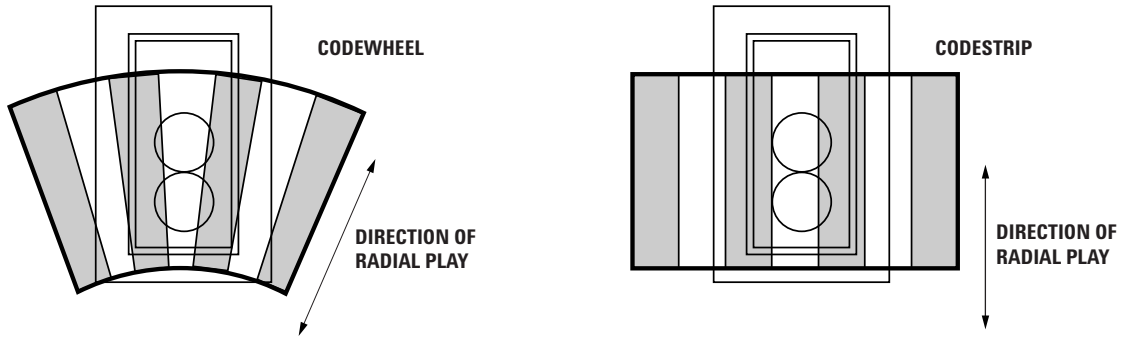

NOTE: DRAWING NOT TO SCALE

Mounting Consideration

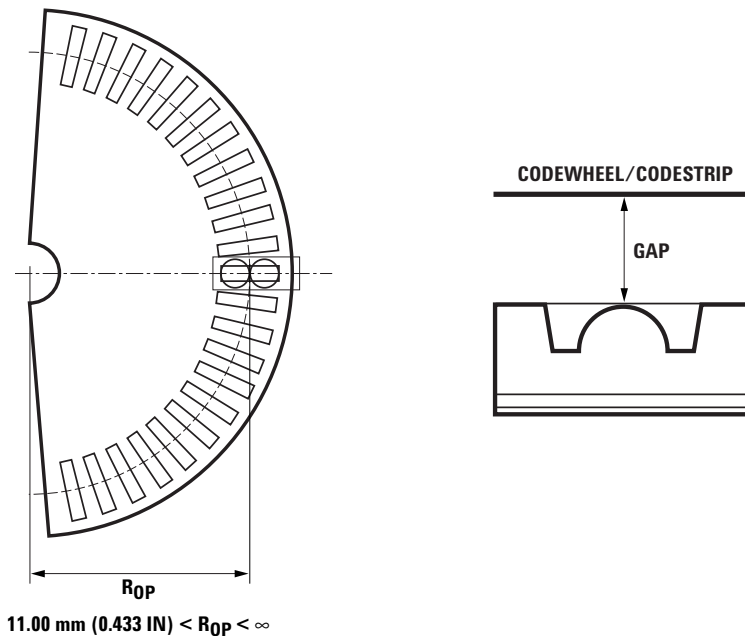

NOTE: DRAWING NOT TO SCALE

Direction of Codewheel Rotation

With the emitter side of the encoder placed closer to the codewheel centre, Channel B leads Channel A when the codewheel rotates anti-clockwise and vice versa.

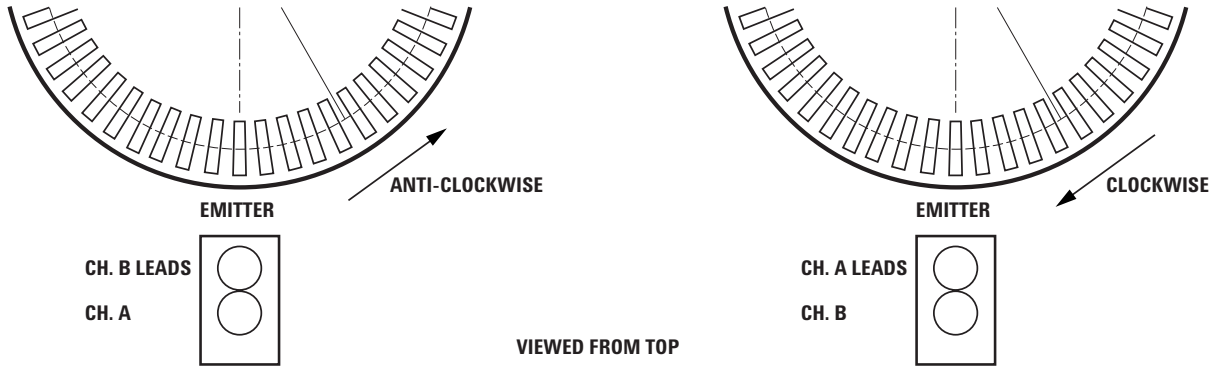

NOTE: DRAWING NOT TO SCALE

Recommended Land Pattern for AEDR-8320

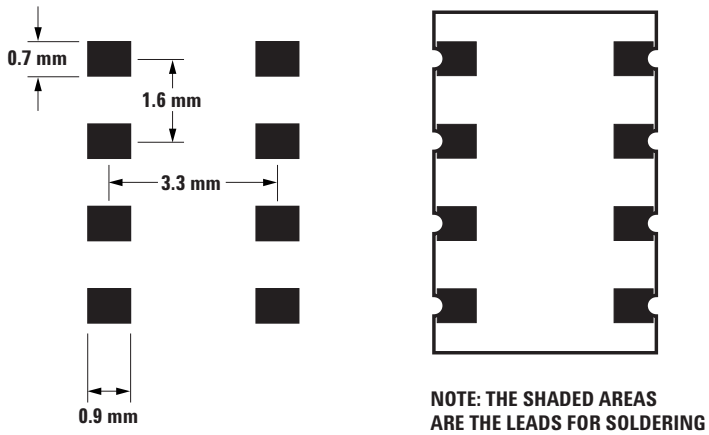

Recommended Lead-Free Reflow Soldering Temperature Profile

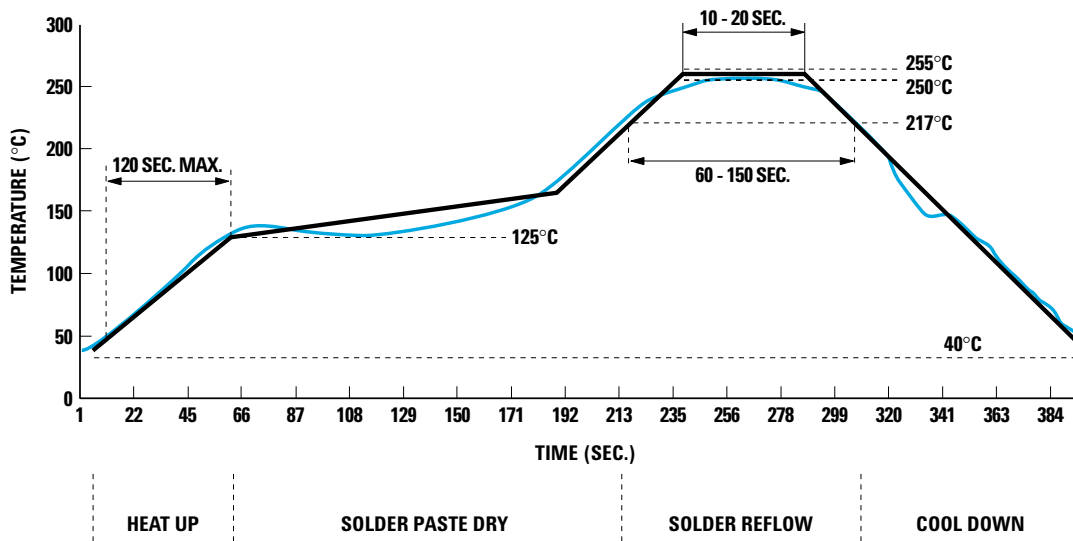

PREHEAT TEMPERATURE 40°C to 125°C = 120 SEC. MAX.
TEMPERATURE MAINTAIN ABOVE 217°C = 60 – 150 SEC.
PEAK TEMPERATURE = 250 ± 5°C
TIME ABOVE 250°C = 10 – 20 SEC.

Note: Due to treatment of high temperature, AEDR-8320 compound may turn yellow after IR reflow.

Ordering Information

AEDR-8320 Option

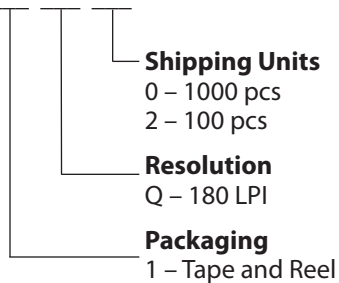

Revision History

Rev.	Date	Note
0	August 2006	Preliminary datasheet creation
1	February 2007	Release data sheet

For product information and a complete list of distributors, please go to our website: www.avagotech.com

Avago, Avago Technologies, and the A logo are trademarks of Avago Technologies Limited in the United States and other countries. Data subject to change. Copyright © 2007 Avago Technologies Limited. All rights reserved.
 AV02-0233EN - October 3, 2007

AVAGO
 TECHNOLOGIES