

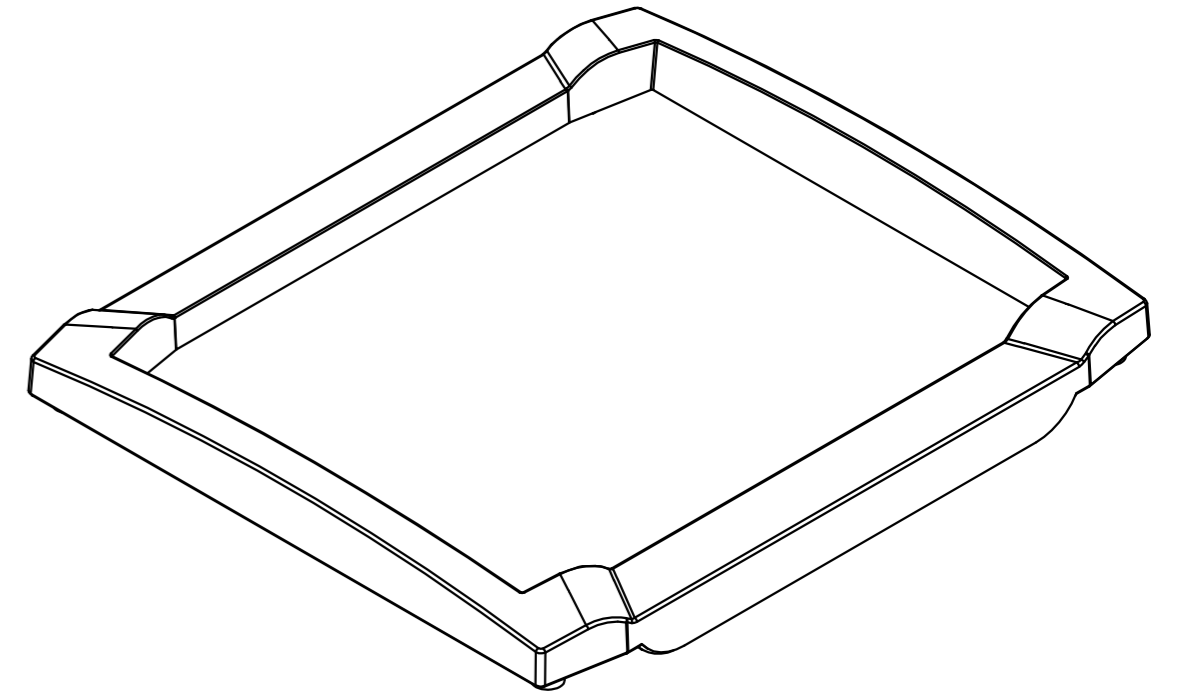

"Schutzvermerk nach DIN ISO 16016 beachten." "Please pay attention to copyright note DIN ISO 16016"

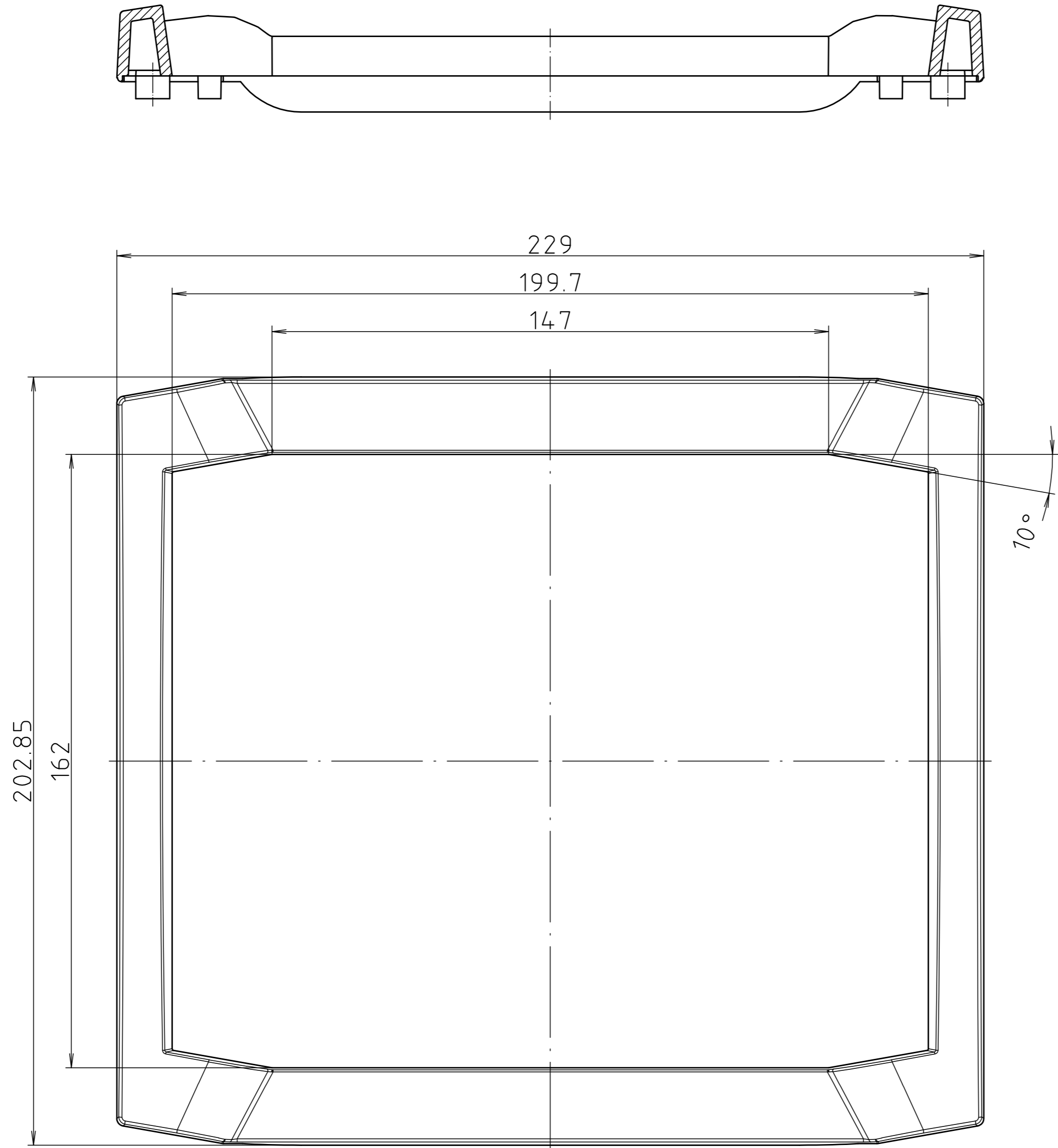

Maßstab/ Scale:	1:1	
Zeichnungs-Nr. / Drawing-No.:	2K 5335.084.01	
Artikel / Article:	BCD 200 FO	
	- Katalogzeichnung/Catalogue drawing	
A.Nr./ Alt-No.:	Datum/ Date:	
DISK:	2 602 385	
Datum/Date:	31.03.04 KH	

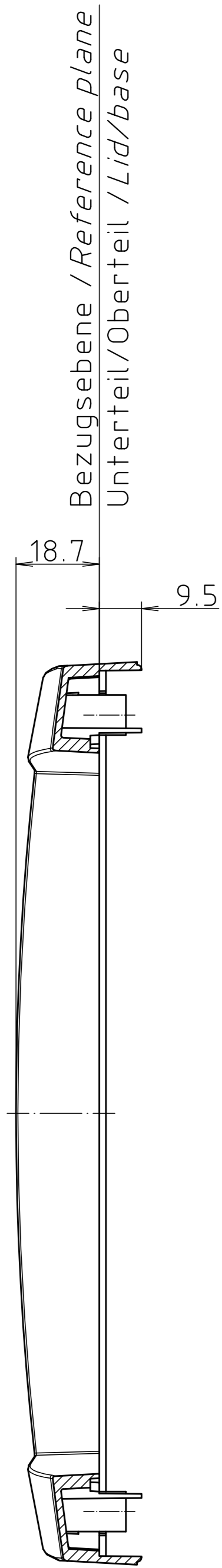

BOPLA
A Phoenix Mecano Company