



10CTQ150  
10CTQ150S  
10CTQ150-1

SCHOTTKY RECTIFIER

10 Amp





Major Ratings and Characteristics

Characteristics	Values	Units
$I_{F(AV)}$ Rectangular waveform	10	A
$V_{RRM}$	150	V
$I_{FSM}$ @ $t_p = 5 \mu s$ sine	620	A
$V_F$ @ 5 Apk, $T_J = 125^\circ C$ (per leg)	0.73	V
$T_J$ range	-55 to 175	$^\circ C$

Description/ Features

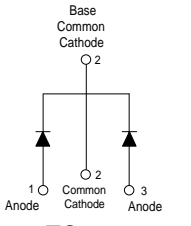
This center tap Schottky rectifier has been optimized for low reverse leakage at high temperature. The proprietary barrier technology allows for reliable operation up to 175° C junction temperature. Typical applications are in switching power supplies, converters, free-wheeling diodes, and reverse battery protection.

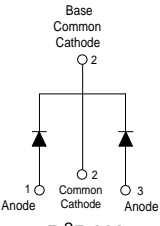
- 175° C  $T_J$  operation
- Center tap configuration
- Low forward voltage drop
- High purity, high temperature epoxy encapsulation for enhanced mechanical strength and moisture resistance
- High frequency operation
- Guard ring for enhanced ruggedness and long term reliability

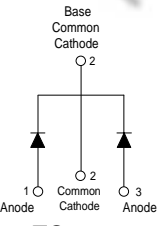
Case Styles		
<p>10CTQ150</p>  <p>Base Common Cathode</p>  <p>TO-220</p>	<p>10CTQ150S</p>  <p>Base Common Cathode</p>  <p>D<sup>2</sup>PAK</p>	<p>10CTQ150 -1</p>  <p>Base Common Cathode</p>  <p>TO-262</p>

## Voltage Ratings

Parameters	10CTQ150 10CTQ150S 10CTQ150-1
$V_R$ Max. DC Reverse Voltage (V)	150
$V_{RWM}$ Max. Working Peak Reverse Voltage (V)	

## Absolute Maximum Ratings

Parameters	Values	Units	Conditions
$I_{F(AV)}$ Max. Average Forward (Per Leg) Current * See Fig. 5 (Per Device)	5	A	50% duty cycle @ $T_C = 155^\circ\text{C}$ , rectangular wave form
	10		
$I_{FSM}$ Max. Peak One Cycle Non-Repetitive Surge Current (Per Leg) * See Fig. 7	620	A	5 $\mu\text{s}$ Sine or 3 $\mu\text{s}$ Rect. pulse 10ms Sine or 6ms Rect. pulse
	115		
$E_{AS}$ Non-Repetitive Avalanche Energy (Per Leg)	6.75	mJ	$T_J = 25^\circ\text{C}$ , $I_{AS} = 0.30$ Amps, $L = 150$ mH
$I_{AR}$ Repetitive Avalanche Current (Per Leg)	0.30	A	Current decaying linearly to zero in 1 $\mu\text{sec}$ Frequency limited by $T_J$ max. $V_A = 1.5 \times V_R$ typical

## Electrical Specifications

Parameters	Values	Units	Conditions
$V_{FM}$ Max. Forward Voltage Drop (Per Leg) * See Fig. 1 (1)	0.93	V	@ 5A
	1.10	V	@ 10A
	0.73	V	@ 5A
	0.86	V	@ 10A
$I_{RM}$ Max. Reverse Leakage Current (Per Leg) * See Fig. 2 (1)	0.05	mA	$T_J = 25^\circ\text{C}$
	7	mA	$T_J = 125^\circ\text{C}$
$V_{F(TO)}$ Threshold Voltage	0.468	V	$T_J = T_J$ max.
$r_t$ Forward Slope Resistance	28	m $\Omega$	
$C_T$ Max. Junction Capacitance (Per Leg)	200	pF	$V_R = 5V_{DC}$ , (test signal range 100Khz to 1Mhz) $25^\circ\text{C}$
$L_S$ Typical Series Inductance (Per Leg)	8.0	nH	Measured lead to lead 5mm from package body
$dv/dt$ Max. Voltage Rate of Change (Rated $V_R$ )	10000	V/ $\mu\text{s}$	

(1) Pulse Width < 300 $\mu\text{s}$ , Duty Cycle <2%

## Thermal-Mechanical Specifications

Parameters	Values	Units	Conditions
$T_J$ Max. Junction Temperature Range	-55 to 175	$^\circ\text{C}$	
$T_{stg}$ Max. Storage Temperature Range	-55 to 175	$^\circ\text{C}$	
$R_{thJC}$ Max. Thermal Resistance Junction to Case (Per Leg)	3.50	$^\circ\text{C}/\text{W}$	DC operation
$R_{thJC}$ Max. Thermal Resistance Junction to Case (Per Package)	1.75	$^\circ\text{C}/\text{W}$	DC operation
$R_{thCS}$ Typical Thermal Resistance, Case to Heatsink (only for TO-220)	0.50	$^\circ\text{C}/\text{W}$	Mounting surface, smooth and greased
wt Approximate Weight	2 (0.07)	g (oz.)	
T Mounting Torque	Min.	6 (5)	Kg-cm (lbf-in)
	Max.	12 (10)	

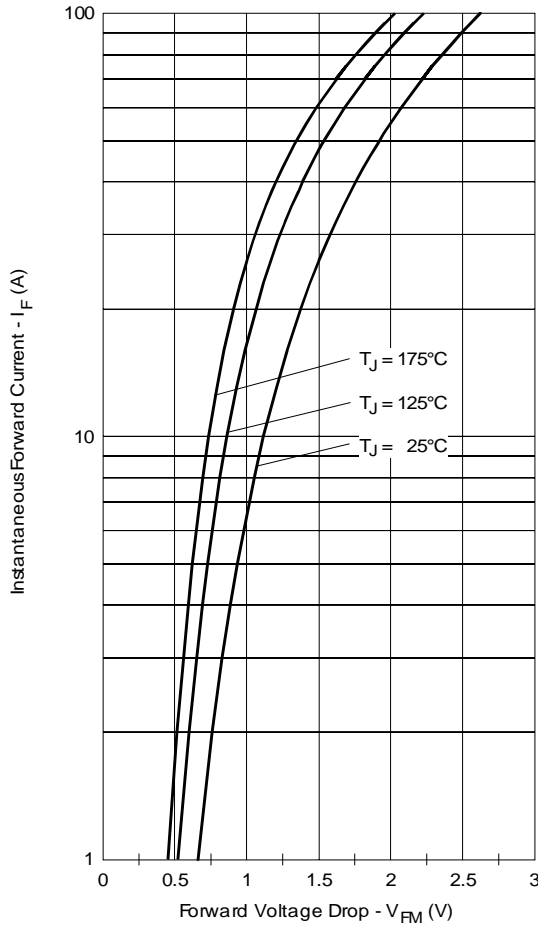

Fig. 1 - Max. Forward Voltage Drop Characteristics (Per Leg)

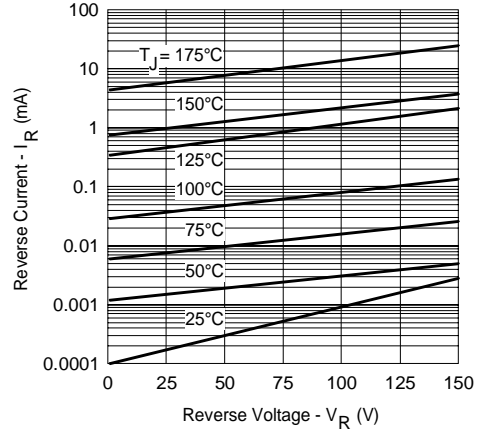

Fig. 2 - Typical Values Of Reverse Current Vs. Reverse Voltage (Per Leg)

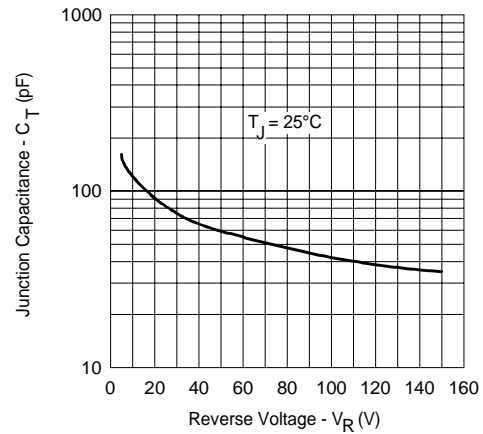

Fig. 3 - Typical Junction Capacitance Vs. Reverse Voltage (Per Leg)

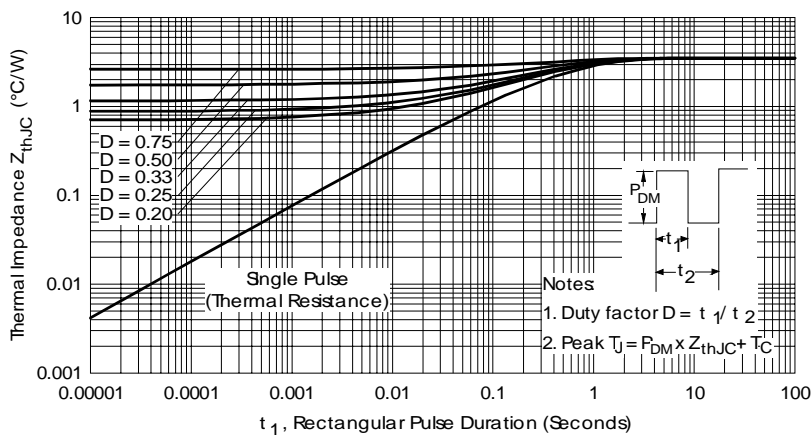

Fig. 4 - Max. Thermal Impedance  $Z_{thJC}$  Characteristics (Per Leg)

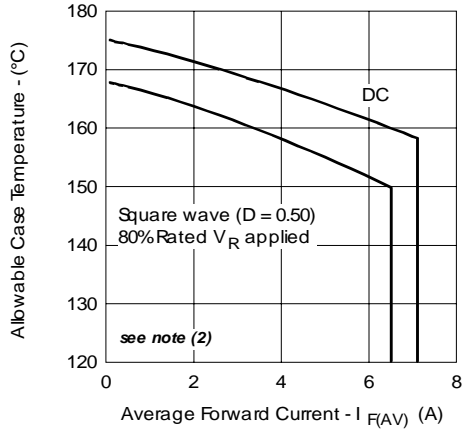

Fig. 5 - Max. Allowable Case Temperature Vs. Average Forward Current (Per Leg)

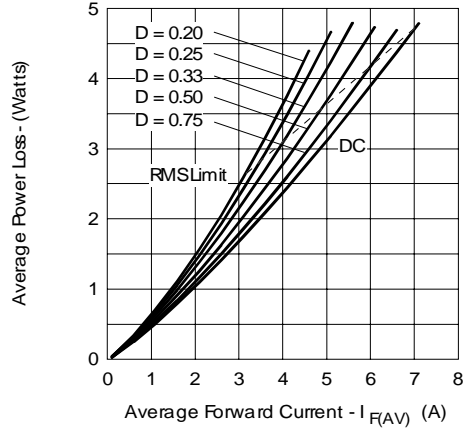

Fig. 6 - Forward Power Loss Characteristics (Per Leg)

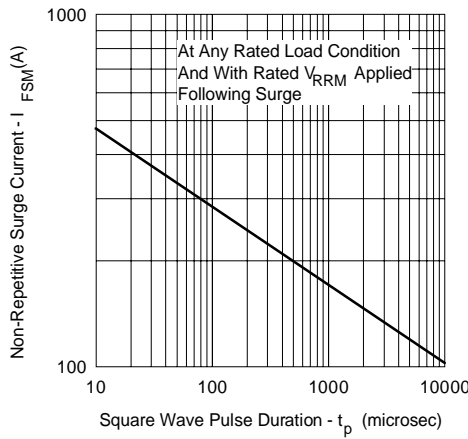

Fig. 7 - Max. Non-Repetitive Surge Current (Per Leg)

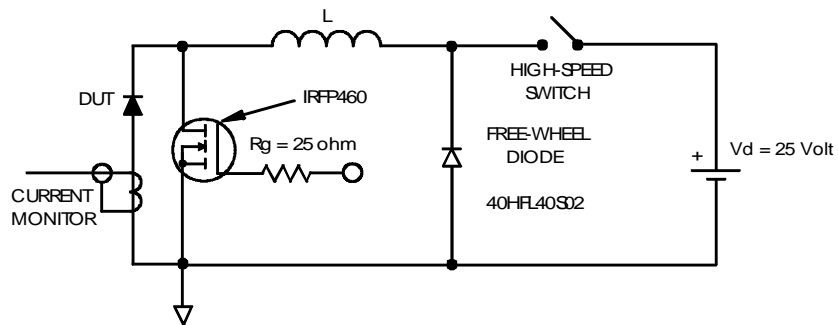

Fig. 8 - Unclamped Inductive Test Circuit

(2) Formula used:  $T_c = T_j - (Pd + Pd_{REV}) \times R_{thJC}$ ;

$Pd$  = Forward Power Loss =  $I_{F(AV)} \times V_{FM} @ (I_{F(AV)} / D)$  (see Fig. 6);

$Pd_{REV}$  = Inverse Power Loss =  $V_{R1} \times I_R (1 - D)$ ;  $I_R @ V_{R1} = 10V$

Outline Table

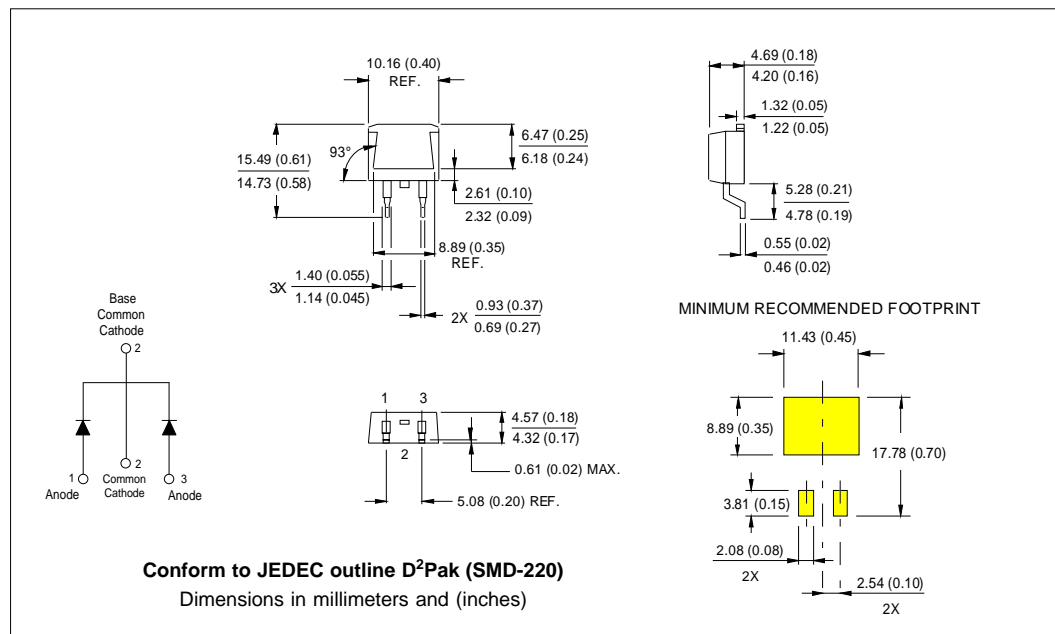
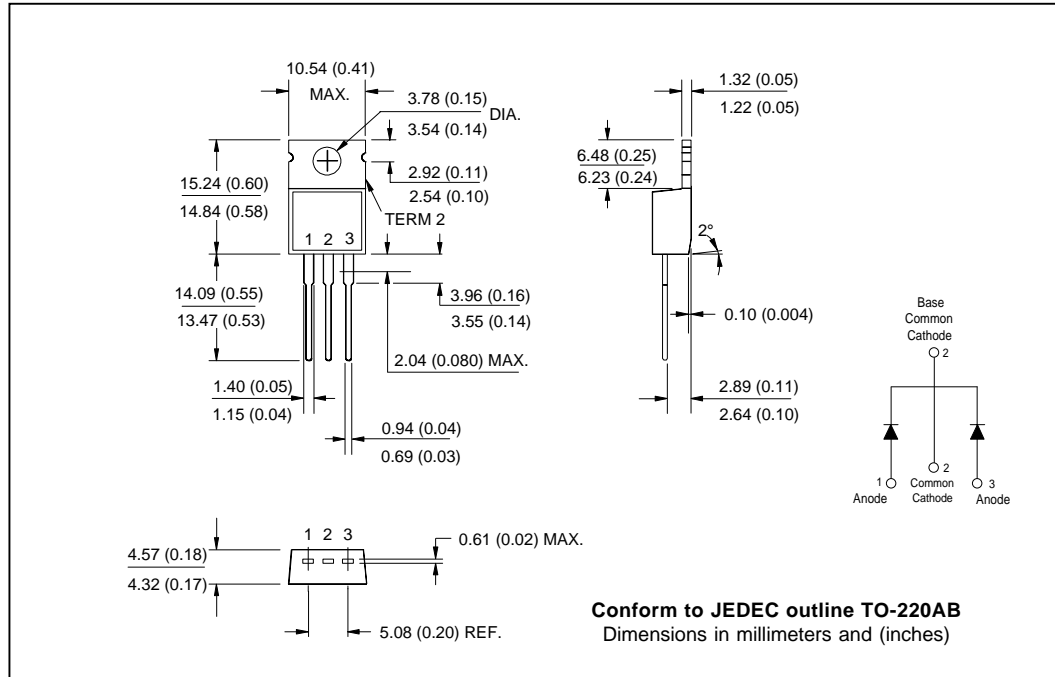

Outline Table

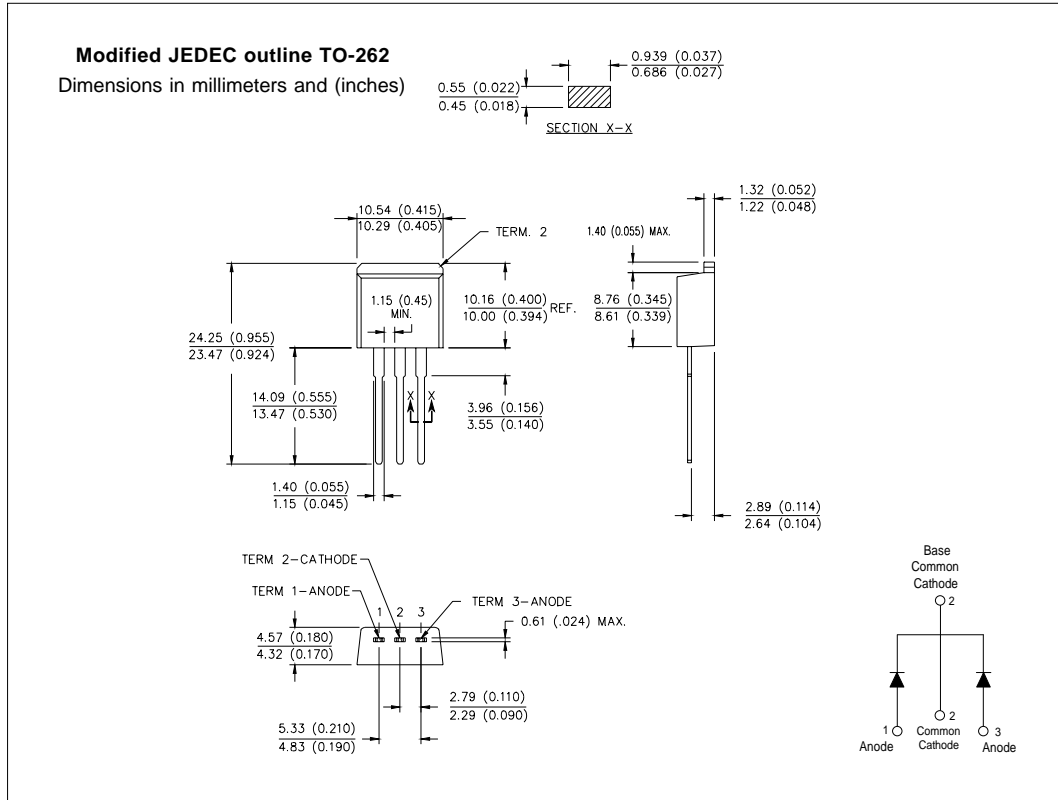

Marking Information

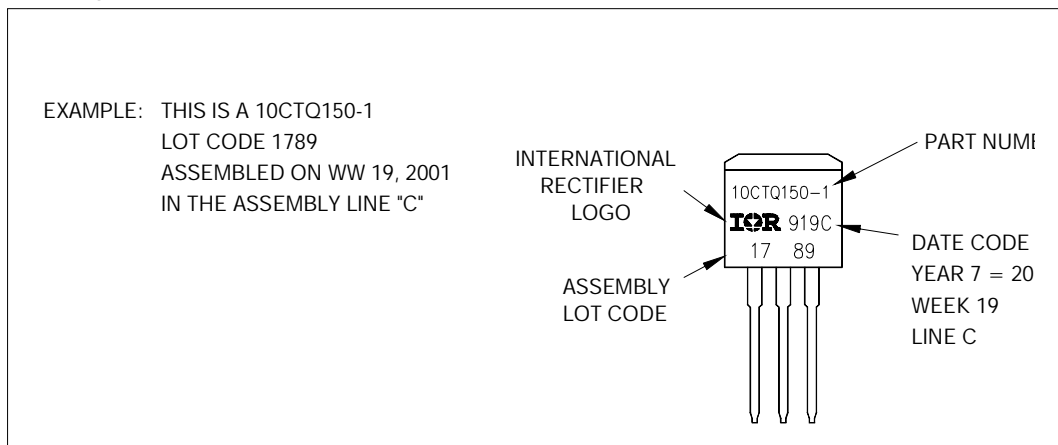

Tape & Reel Information

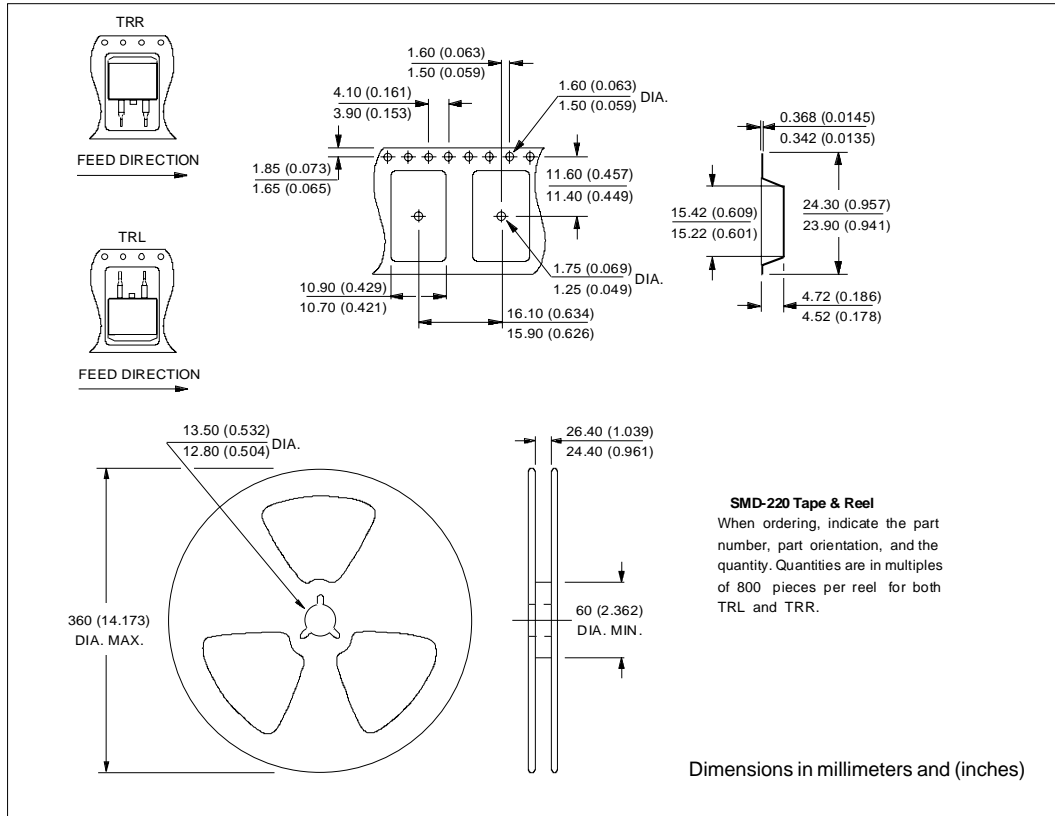

Ordering Information Table

Device Code					
10	C	T	Q	150	-1
①	②	③	④	⑤	⑥
1	-	Essential Part Number			
2	-	C = Common Cathode			
3	-	T = TO-220			
4	-	Q = Schottky Q Series			
5	-	Voltage Rating 150 = 150V			
6	-	1 = TO-262 S = D <sup>2</sup> Pak			

10CTQ150, 10CTQ150S, 10CTQ150-1

Bulletin PD-2.291 rev. C 03/03

International  
**IOR** Rectifier

---

Data and specifications subject to change without notice.  
This product has been designed and qualified for Industrial Level.  
Qualification Standards can be found on IR's Web site.

International  
**IOR** Rectifier

**IR WORLD HEADQUARTERS:** 233 Kansas St., El Segundo, California 90245, USA Tel: (310) 252-7105  
TAC Fax: (310) 252-7309  
Visit us at [www.irf.com](http://www.irf.com) for sales contact information. 03/03