



# TRI

## ➤ MAIN FEATURES

- Miniature heavy-duty relays
- Single-Pole, 10 Amp PC Board
- SPST and SPDT configurations
- 5KV dielectric coil to contacts
- Sealed & Unsealed types available
- UL, cUL and TUV recognized.

## ➤ APPLICATIONS

- Microwave Ovens, Facsimiles, Refrigerators
- Air Conditioners, Stereo Equipment,
- Copier, TV Set, Vending Machines,
- Temperature Controllers, etc.

## ➤ ORDERING INFORMATION

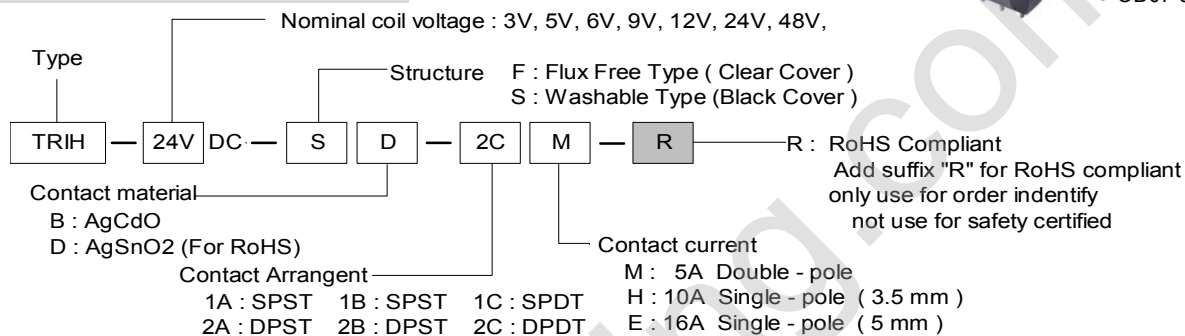

### Option Socket :

Please refer appendix P102



- OD07-0017A
- OD07-0018A
- OD07-0019A
- OD07-0020A

## ■ DIMENSION (unit:mm)

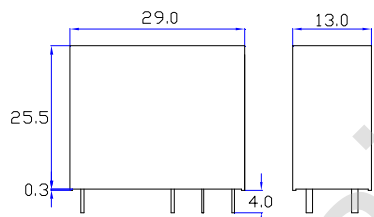

TRIH-1AE

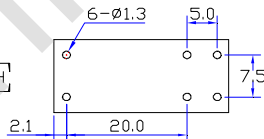

TRIH-1CE

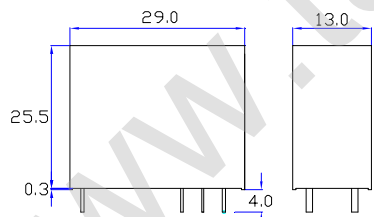
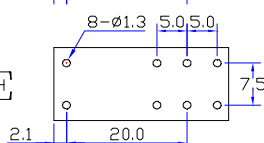

TRIH-1AH

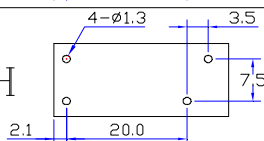

TRIH-1CH

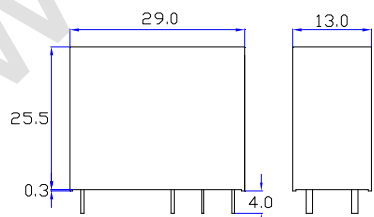
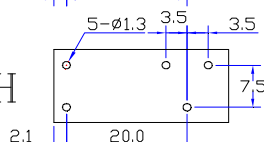

TRIH-2AM

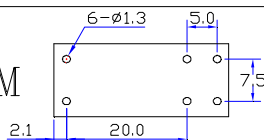

TRIH-2CM

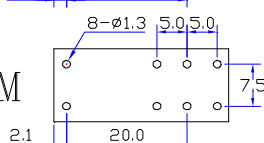

## ■ WIRING DIAGRAM

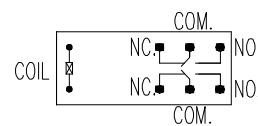
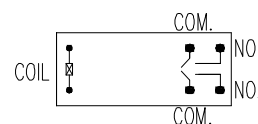
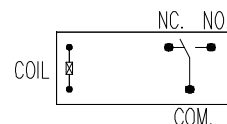
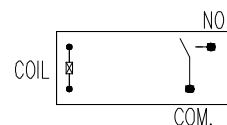
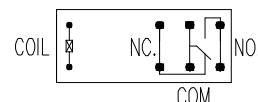
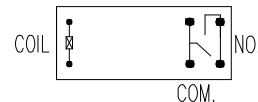

### ➤ COIL DATA CHART(AT20°C)

Nominal Voltage (VDC)	Nominal Current (mA ±10%)	Coil Resistance (Ω ±10%)	Power Consumption (mW)	Pick-Up Voltage VDC(Max.)	Drop-out Voltage VDC(Min.)	allowable Voltage VDC (Max.)
3	176	17	Approx. 530	80% Max.	10% Min. of nominal voltage	110% of nominal voltage
5	106	47				
6	88.2	68				
9	56.2	160				
12	43.6	275				
24	21.8	1100±15%				
48	11.5	4170±15%				

### ➤ CONTACT RATING

Arrangement	E-Type		H-Type		M-Type	
	SPST-NO. (1 Form A)	SPDT (1 Form C)	SPST-NO. (1 Form A)	SPDT (1 Form C)	DPST-NO. (2 Form A)	DPDT (2 Form C)
Resistive load (cosφ=1)	UL		10A 277VAC 10A 30VDC TV-5 125VAC 1/3HP 250VAC 1/4HP 125VAC		10A 250VAC 10A 30VDC 8A 30VDC TV-3 125VAC 1/4HP 240VAC 1/8HP 120VAC	
	TUV		10A 250VAC 10A 30VDC		5A 250VAC 5A 30VDC	
Carrying current	16A		10A		5A	
Max. switching voltage	277VAC, 30VDC		277VAC, 30VDC		250VAC, 30VDC	
Max. switching current	16A		10A		5A	
Max. switching power	4000VA 300W	2000VA 192W	2500VA 300W	1875VA 150W	1250VA 150W	500VA 90W
Min. permissible load	DC 5V 100mA			DC 5V 10mA		
Contact material	Ag Alloy					

### ➤ PERFORMANCE (at initial value)

Item	Type	TRI-H
Contact Resistance		50mΩ Max.
Operation time		15msec Max. (at nominal voltage)
Release time		10msec Max. (at nominal voltage)
Dielectric strength	between coil & contact. between contact sets. between open contacts.	5000VAC. for 1minute 3000VAC. for 1minute 1000VAC. for 1minute
Insulation Resistance		100MΩ Min. (at 500VDC)
Operating frequency		20 ops/minute
Ambient temperature		-40°C to +70°C
Storage		-40°C to +70°C
Operating		-40°C to +70°C
Humidity		35% to 85% RH
Vibration resistance		10 to 55 Hz, 1.5mm double amplitude
Shock resistance		
Functional :		98m/s <sup>2</sup>
Destructive :		980m/s <sup>2</sup>
Life expectancy		
Mechanical :		1 x 10 <sup>7</sup> operations
Electrical :		1 x 10 <sup>5</sup> operations (at rated load)
Weight		Approx. 18grs.
UL & cUL		E156406
TUV		R50053235 / R50058882 / R50058874

### ➤ REFERENCE DATA

#### Maximum Switched Power

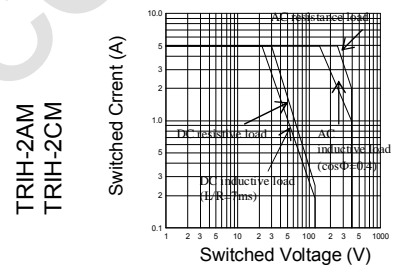
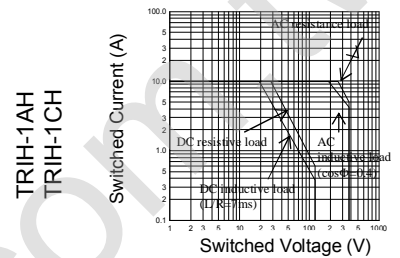
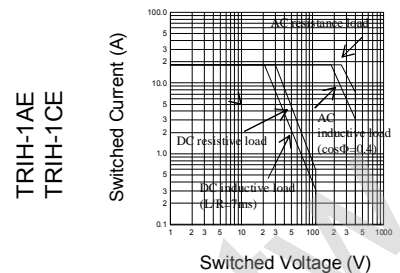

#### Electrical Life Expectancy

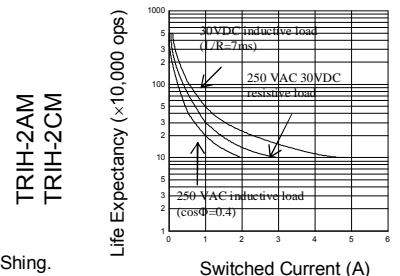
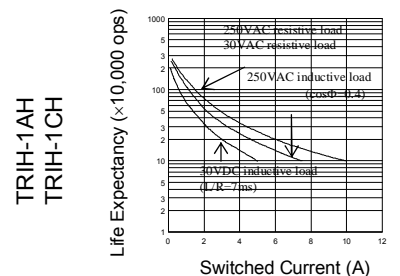
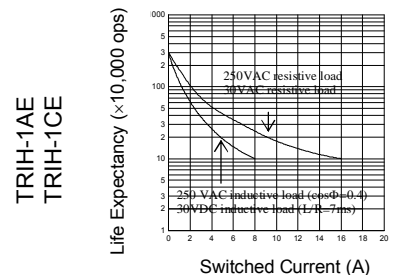

This datasheet for reference and subject to change without notice. Please double check final specification with Tai-Shing. (0939AA08VOL01)