

- 1. COORDINATE DIMENSION APPLIES FROM BASIC LOCATION.
- 2. 10 AND 14 POSITION SIZES CONTAIN ONLY ONE SLOT FOR SNAP-IN POLARIZER (MILITARY POLARIZATION) LOCATED AS SHOWN.
- 3. 10 POSITION SIZES CONTAIN ONLY ONE SLOT FOR DUAL POLARIZATION, LOCATED AS SHOWN.
- 4. RECOMMENDED PRINTED CIRCUIT BOARD THICKNESS IS 1.57 [.062].
- 5. DISTANCE REQUIRED BY EJECTION LATCHES IN THE OPEN POSITION.
- 6. MATERIAL HOUSING & LATCHES: GLASS FILLED NYLON OR POLYESTER, UL94V-0 RATED BLACK. POSTS: BRASS.
- 7. POSTS:
GOLD FLASH OVER PALLADIUM-NICKEL PLATE, 0.38μm [.000015] MIN TOTAL ON THE LOCALIZED PLATE AREA,
2.54μm [.000100] MIN TIN PLATE ON THE SOLDER-TAILS,
1.27μm [.000050] MIN NICKEL UNDERPLATE ON THE ENTIRE POST.
OR
0.38μm [.000015] MIN GOLD PLATE ON THE LOCALIZED PLATE AREA,
2.54μm [.000100] MIN TIN PLATE ON THE SOLDER-TAILS,
1.27μm [.000050] MIN NICKEL UNDERPLATE ON THE ENTIRE POST.
- 8. DATUMS M & N TO BE ESTABLISHED BY CUSTOMER.

EJECTION LATCHES OMITTED IN THIS VIEW FOR CLARITY

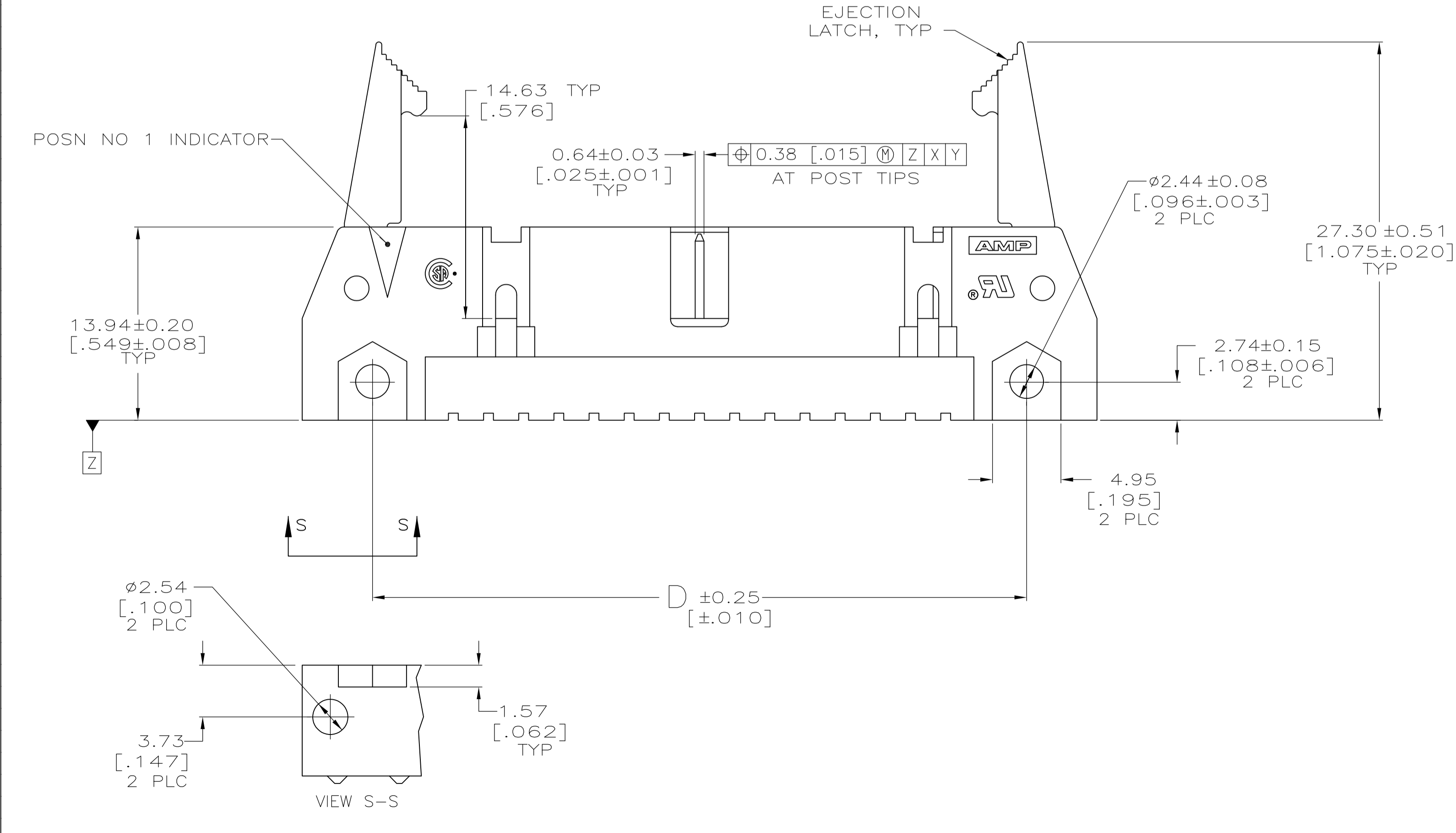
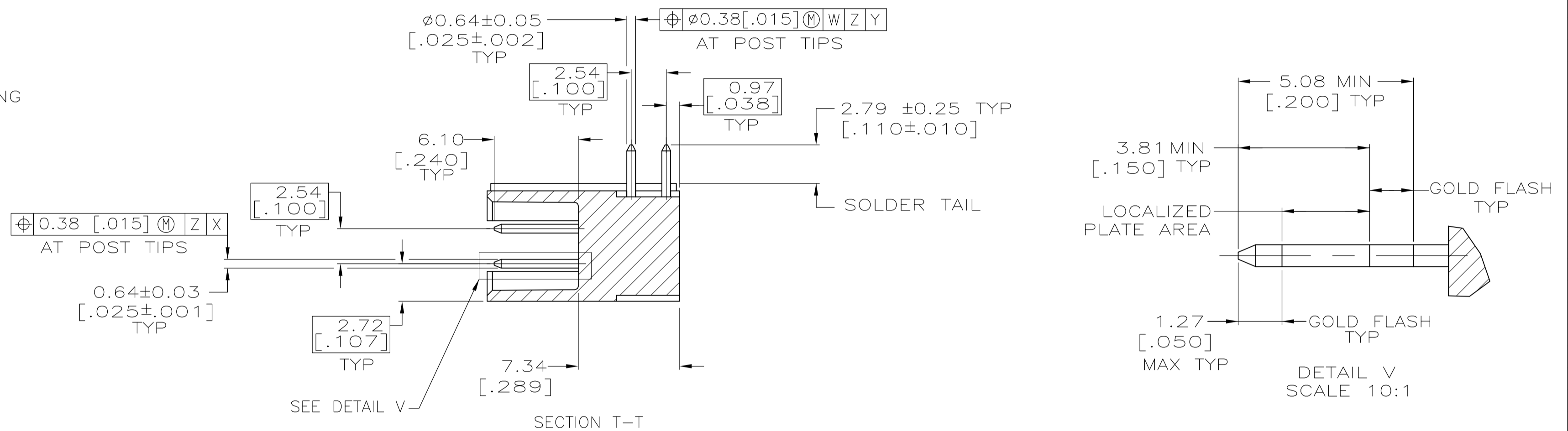
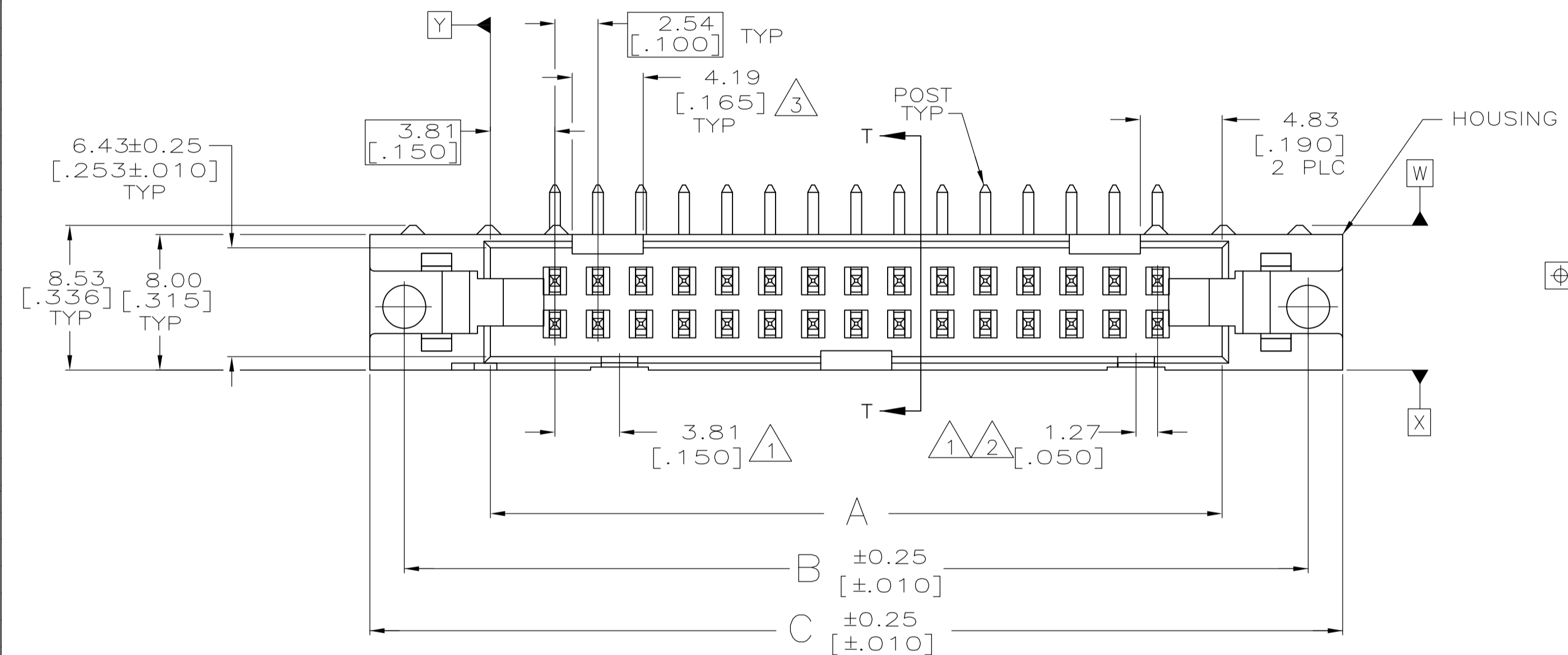

	78.74 [3.100]	90.42 [3.560]	90.42 [3.560]	100.58 [3.960]	96.52 [3.800]	86.36 [3.400]	64	1-5499786-2
	73.66 [2.900]	85.34 [3.360]	85.34 [3.360]	95.50 [3.760]	91.44 [3.600]	81.28 [3.200]	60	1-5499786-1
	60.96 [2.400]	72.64 [2.860]	72.64 [2.860]	82.80 [3.260]	78.74 [3.100]	68.58 [2.700]	50	1-5499786-0
	48.26 [1.900]	59.94 [2.360]	59.94 [2.360]	70.10 [2.760]	66.04 [2.600]	55.88 [2.200]	40	5499786-9
	40.64 [1.600]	52.32 [2.060]	52.32 [2.060]	62.48 [2.460]	58.42 [2.300]	48.26 [1.900]	34	5499786-8
OBSOLETE	35.56 [1.400]	47.24 [1.860]	47.24 [1.860]	57.40 [2.260]	53.34 [2.100]	43.18 [1.700]	30	5499786-7
	30.48 [1.200]	42.16 [1.660]	42.16 [1.660]	52.32 [2.060]	48.26 [1.900]	38.10 [1.500]	26	5499786-6
	27.94 [1.100]	39.62 [1.560]	39.62 [1.560]	49.78 [1.960]	45.72 [1.800]	35.56 [1.400]	24	5499786-5
	22.86 [.900]	34.54 [1.360]	34.54 [1.360]	44.70 [1.760]	40.64 [1.600]	30.48 [1.200]	20	5499786-4
	17.78 [.700]	29.46 [1.160]	29.46 [1.160]	39.62 [1.560]	35.56 [1.400]	25.40 [1.000]	16	5499786-3
	15.24 [.600]	26.92 [1.060]	26.92 [1.060]	37.08 [1.460]	33.02 [1.300]	22.86 [.900]	14	5499786-2
	10.16 [.400]	21.84 [.860]	21.84 [.860]	32.00 [1.260]	27.94 [1.100]	17.78 [.700]	10	5499786-1
	F	E	D	C	B	A	NO OF POSN	PART NUMBER

THIS DRAWING IS A CONTROLLED DOCUMENT.

DIMENSIONS: mm (INCHES)	TOLERANCES UNLESS OTHERWISE SPECIFIED:	DIN L VARELA - DOOKS 01-07-05	CHK S BOLASH 01-07-05	APVD M WALMSLEY 01-07-05	NAME	
0 PLC ± -	1 PLC ± -	2 PLC ± 0.13[.005]	3 PLC ± -	4 PLC ± -	ANGLES ± -	
MATERIAL	FINISH	WEIGHT	SIZE	CAGE CODE	DRAWING NO	RESTRICTED TO
			A1	00779	5499786	

CUSTOMER DRAWING SCALE 4:1 SHEET 1 OF 1 REV E

Mouser Electronics

Authorized Distributor

Click to View Pricing, Inventory, Delivery & Lifecycle Information:

[TE Connectivity:](#)

[5499786-1](#)