

Proximity Sensors



- Non-contact involved, strong abrasive resistance, high stability.
- Highly sensitive and intense accuracy, life span up to 8 years.
- Variety of popular materials, such as stainless steel, nickel copper alloy plastic and Teflon coating.
- Includes a complete range of specifications, and sizes.
- IP67 protection design, excellent water and oil resistance.



Standard Distance Type (TR series)

- Classical cylindrical appearance, high stability
- Adaptive to different occasions, top-notch quality, low price
- Customizable cables & connectors as requested

P.E-17

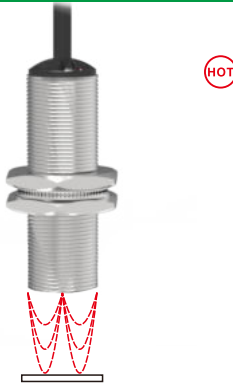

Extended Distance Type (TL series)

- sensing distance is double that of standard products
- Save installing space effectively
- Customizable cables & connectors at your request

P.E-20



Long Distance Type (TY series)

- Ultra-long sensing distance, up to 40mm
- Avoid any attenuation caused by the material of detected objects
- Ip67 high protection degree

P.E-23



Square Type (TQ series)

- Kidney-shaped hole, easy installation
- Up to 8 mm sensing distance
- Plastic housing, protection degree IP67

P.E-26



Mini-square Type (TE series)

- 6mm (extra small), built-in amplifier
- 8mm sensing distance, the longest sensing distance in the industry
- Sensing surface on the top and at the front to suit your needs

P.E-27



Mini-cylindrical Type (TX series)

- Highly stabilized detection in narrow space
- Shield type, can be embedded in detecting objects
- $\Phi 3, \Phi 4, M4, M5$, various models for you to choose from

P.E-29

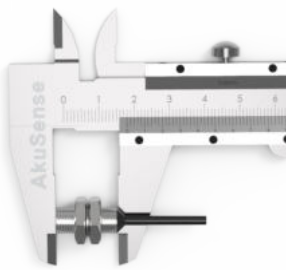

Short-body Type (TSS/TS series)

- Compared with similar sensors, the length can be shortened 1/3
- 18mm body length can perfectly fit into narrow space
- Epoxy resin fillings exhibit excellent shock resistance

P.E-31



Ring-type (TH series)

- 2mm thickness, the thinnest one in the industry
- Stainless steel casing; strong impact resistance
- Flexible sensitivity adjustment with knobs

P.E-34



Metal Face Type (TM series)

- Stainless steel face, with great impact resistance
- 1000PSI/High pressure resistance
- Wonderful thermal shock and chemical resistance

P.E-35

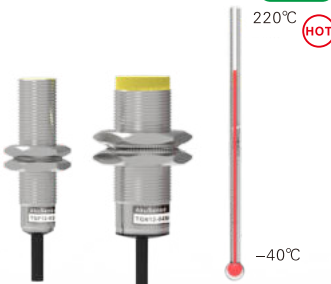

Temperature Resistance Type (TG/TZ series)

- Extended temperature varies from -40°C to $+220^{\circ}\text{C}$
- Degree of protection up to IP67
- Reverse polarity protection and surge protection

P.E-37



IP69K High Protection (TP series)

- AISI 316L stainless steel housing
- IP67-IP68-IP69K protection level
- Can be used in the food and beverage field

P.E-39

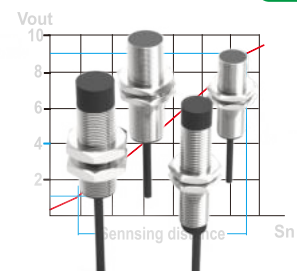

Analog Output Type (TA series)

- First choice of short distance and non-contact detection
- Analog output 0~20mA and 0~10v
- Output PNP-Analog

P.E-41

Guidance

Inductive sensors

- Standard distance
- Extended distance
- Long distance
- Square
- Mini square
- Mini-cylindrical
- Short-body
- Ring-type
- Metal face
- Temperature
- Analog output
- DC 2 wires
- IP69K high protection

Capacitive sensors

- Cylindrical
- Correction resistanc type
- Flat type
- Level detection



DC 2-wire Type (TD series)

- Nonpolarized specifications, easy wiring method
- With smallest sensing surface M8
- 10~30V DC and 10~60V DC ,two voltages

P.E-40



Cylindrical Type (CK series)

- Detect metal, plastic and liquid, ect
- With reverse polarity, short circuit, surge and many other protection functions
- Metal and plastic housings are available

P.E-42



Corrosion Resistant Type (CWF series)

- Up to 20 turns sensitivity adjustment
- Teflon coatings ensure superior corrosion resistance
- Widely used in detection of metals, water, oil, glasses, plastic and water, etc

P.E-43



Flat Type (CQ series)

- 7mm of thickness only for saving space
- Enjoy stability; comparable to world famous brands
- Offer different kinds of sensing distance of 5mm, 6mm, 7mm and 10mm, etc

P.E-44



Liquid Level Detection (CE series)

- Free from influence of liquid color in pipeline
- Suitable for pipeline diameter from $\Phi 8$ mm to $\Phi 11$ mm, $\Phi 12$ mm to $\Phi 26$ mm
- With built-in amplifier to save installing space

P.E-45

Fiber Optic
Slot Sensors
Photoelectric
Laser
Proximity
Displacement
Magnetic
Contact
Area
Ultrasonic
Vibration
Temperature
Cables
Tester

Guidance

Inductive sensors
Standard distance
Extended distance
Long distance
Square
Mini square
Mini-cylindrical
Short-body
Ring-type
Metal face
Temperature
Analog output
DC 2 wires
IP69K high protection

Capacitive sensors
Cylindrical
Corrosion resistant type
Flat type
Level detection

Type 1	Type 2	Series	
Inductive Sensors	Cylindrical	Standard Distance	TR Series
		Extended Distance	TL Series
		Long Distance	TY Series
		Mini-cylindrical	TX Series
		Short-body	TSS/TS Series
		Analog Output	TA Series
	Square	DC 2-wire	TD Series
		Standard Square	TQ Series
		Mini-square	TE Series
	Special Applications	Ring-type	TH Series
		Metal Face	TM Series
		Temperature Resistance	TG/TZ Series
		IP69K High Protection	TP Series
Capacitive Sensors	Cylindrical	Plastic Shells	CK Series
	Corrosion Resistant	Teflon Shells	CWF Series
	Flat	Plastic Shells	CQ Series
	Special Applications	Liquid Level Detecion	CE Series

- Fiber Optic
- Slot Sensors
- Photoelectric
- Laser
- Proximity**
- Displacement
- Magnetic
- Contact
- Area
- Ultrasonic
- Vibration
- Temperature
- Cables
- Tester

Guidance

- Inductive sensors**
- Standard distance
- Extended distance
- Long distance
- Square
- Mini square
- Mini-cylindrical
- Short-body
- Ring-type
- Metal face
- Temperature
- Analog output
- DC 2 wires
- IP69K high protection

- Capacitive sensors**
- Cylindrical
- Corrosion resistant type
- Flat type
- Level detection

Guidance

Standard Distance DC 3-wire

Type	Appearance	Sensing distance		Model numbers		Pages	
		Unit: mm		NPN Normally open	NPN Normally closed		
Pre-wired Type	Shielded		$\phi 6.5 \times 45.5$	1.5mm	TRF6.5-1.5NO	TRF6.5-1.5NC	E-17
			M8*45	1.5mm	TRF08-1.5NO	TRF08-1.5NC	
			M12*44.5	2mm	TRF12-02NO	TRF12-02NC	
			M18*55	5mm	TRF18-05NO	TRF18-05NC	
			M30*54	10mm	TRF30-10NO	TRF30-10NC	
	Unshielded		$\phi 6.5 \times 45$	2mm	TRN6.5-02NO	TRN6.5-02NC	
			M8*45.5	2mm	TRN08-02NO HOT	TRN08-02NC	
			M12*46.5	4mm	TRN12-04NO HOT	TRN12-04NC	
			M18*54	8mm	TRN18-08NO	TRN18-08NC	
			M30*58	15mm	TRN30-15NO	TRN30-15NC	
Connector Type	Shielded		M8*60	1.5mm	TRF08-1.5NO-E1	TRF08-1.5NC-E1	
			M12*68	2mm	TRF12-02NO-E2	TRF12-02NC-E2	
			M18*82	5mm	TRF18-05NO-E2	TRF18-05NC-E2	
			M30*78	10mm	TRF30-10NO-E2	TRF30-10NC-E2	
			M8*60	2mm	TRN08-02NO-E1	TRN08-02NC-E1	
	Unshielded		M12*67	4mm	TRN12-04NO-E2	TRN12-04NC-E2	
			M18*78	8mm	TRN18-08NO-E2	TRN18-08NC-E2	
			M30*78	15mm	TRN30-15NO-E2	TRN30-15NC-E2	

Noted: Model numbers ended with "PO"/"PO-E1"/"PO-E2" are PNP normally open ; model numbers ended with "PC"/"PC-E1"/"PC-E2" are PNP normally closed.

Extended Distance DC 3-wire

Type	Appearance	Sensing distance		Model numbers		Pages	
		Unit: mm		NPN Normally open	NPN Normally closed		
Pre-wired Type	Shielded		$\phi 6.5 \times 45$	2mm	TLF6.5-02NO	TLF6.5-02NC	E-20
			M8*45	2mm	TLF08-02NO	TLF08-02NC	
			M12*45	4mm	TLF12-04NO	TLF12-04NC	
			M18*54	8mm	TLF18-08NO	TLF18-08NC	
			M30*54	16mm	TLF30-16NO	TLF30-16NC	
	Unshielded		$\phi 6.5 \times 44$	4mm	TLN6.5-04NO	TLN6.5-04NC	
			M8*44	4mm	TLN08-04NO HOT	TLN08-04NC	
			M12*53	8mm	TLN12-08NO HOT	TLN12-08NC	
			M18*58	16mm	TLN18-16NO	TLN18-16NC	
			M30*61	25mm	TLN30-25NO	TLN30-25NC	
Connector Type	Shielded		M8*60	2mm	TLF08-02NO-E1	TLF08-02NC-E1	
			M12*68	4mm	TLF12-04NO-E2	TLF12-04NC-E2	
			M18*82	8mm	TLF18-08NO-E2	TLF18-08NC-E2	
			M30*78	16mm	TLF30-16NO-E2	TLF30-16NC-E2	
			M8*60	4mm	TLN08-04NO-E1	TLN08-04NC-E1	
	Unshielded		M12*71	8mm	TLN12-08NO-E2	TLN12-08NC-E2	
			M18*82	16mm	TLN18-16NO-E2	TLN18-16NC-E2	
			M30*81	25mm	TLN30-25NO-E2	TLN30-25NC-E2	

Noted: Model numbers ended with "PO"/"PO-E1"/"PO-E2" are PNP normally open ; model numbers ended with "PC"/"PC-E1"/"PC-E2" are PNP normally closed.

- Fiber Optic
- Slot Sensors
- Photoelectric
- Laser
- Proximity**
- Displacement
- Magnetic
- Contact
- Area
- Ultrasonic
- Vibration
- Temperature
- Cables
- Tester

- Guidance**
- Inductive sensors**
- Standard distance
- Extended distance
- Long distance
- Square
- Mini square
- Mini-cylindrical
- Short-body
- Ring-type
- Metal face
- Temperature
- Analog output
- DC 2 wires
- IP69K high protection
- Capacitive sensors**
- Cylindrical
- Correction resistanc type
- Flat type
- Level detection

Type	Appearance	Sensing distance		Model numbers		Pages	
		Unit: mm		NPN Normally open	NPN Normally closed		
Pre-wired Type	Shielded		$\phi 6.5 \times 45$	3mm	TYF6.5-03NO	TYF6.5-03NC	E-23
			M8*45	3mm	TYF08-03NO	TYF08-03NC	
			M12*45	6mm	TYF12-06NO	TYF12-06NC	
			M18*54	12mm	TYF18-12NO	TYF18-12NC	
			M30*54	22mm	TYF30-22NO	TYF30-22NC	
	Unshielded		$\phi 6.5 \times 44$	6mm	TYN6.5-06NO	TYN6.5-06NC	
			M8*44	6mm	TYN08-06NO	TYN08-06NC	
			M12*53	10mm	TYN12-10NO	TYN12-10NC	
			M18*58	20mm	TYN18-20NO	TYN18-20NC	
			M30*61	40mm	TYN30-40NO	TYN30-40NC	
Connector Type	Shielded		M8*60	3mm	TYF08-03NO-E1	TYF08-03NC-E1	
			M12*68	6mm	TYF12-06NO-E2	TYF12-06NC-E2	
			M18*82	12mm	TYF18-12NO-E2	TYF18-12NC-E2	
			M30*78	22mm	TYF30-22NO-E2	TYF30-22NC-E2	
	Unshielded		M8*60	6mm	TYN08-06NO-E1	TYN08-06NC-E1	
			M12*71	10mm	TYN12-10NO-E2	TYN12-10NC-E2	
			M18*82	20mm	TYN18-20NO-E2	TYN18-20NC-E2	
			M30*81	40mm	TYN30-40NO-E2	TYN30-40NC-E2	

Noted: Model numbers ended with "PO"/"PO-E1"/"PO-E2" are PNP normally open ;model numbers ended with "PC"/"PC-E1"/"PC-E2" are PNP normally closed.

- Fiber Optic
- Slot Sensors
- Photoelectric
- Laser
- Proximity**
- Displacement
- Magnetic
- Contact
- Area
- Ultrasonic
- Vibration
- Temperature
- Cables
- Tester









Guidance

Type	Appearance	Sensing distance		Model numbers		Pages
		Unit: mm		NPN Normally open	NPN Normally closed	
Pre-wired Type	Q17 	Shielded	5mm	TQF17-05NO	TQF17-05NC	E-26
		Unshielded	8mm	TQN17-08NO	TQN17-08NC	
	Q18 	Shielded	5mm	TQF18-05NO (HOT)	TQF18-05NC	
		Unshielded	8mm	TQN18-08NO	TQN18-08NC	
	Q18C 	Shielded	5mm	TQF18C-05NO (HOT)	TQF18C-05NC	
		Unshielded	8mm	TQN18C-08NO	TQN18C-08NC	

Noted: Model numbers ended with "PO" are PNP normally open ;model numbers ended with "PC" are PNP normally closed.



- Inductive sensors**
- Standard distance
- Extended distance
- Long distance
- Square
- Mini square
- Mini-cylindrical
- Short-body
- Ring-type
- Metal face
- Temperature
- Analog output
- DC 2 wires
- IP69K high protection
- Capacitive sensors**
- Cylindrical
- Correction resistancetype
- Flat type
- Level detection

Mini Square DC 3-wire

Type	Appearance	Sensing distance	Model numbers		Pages	
			NPN Normally open	NPN Normally closed		
Pre-wired Type	Unshielded	Unit: mm				
			E06	1mm	TEN06-01NO	TEN06-01NC
		6.2*6.4*20.4				
			E07	1mm	TEN07-01NO	TEN07-01NC
		6.1*6.3*20.4				
			E08	2.5mm	TEN08-2.5NO HOT	TEN08-2.5NC
		8*8.4*23.5		3mm	TEN08-03NO	TEN08-03NC
			E09	2.5mm	TEN09-2.5NO	TEN09-2.5NC
		8*8.4*25.5		3mm	TEN09-03NO HOT	TEN09-03NC
			E10	2.5mm	TEN10-2.5NO	TEN10-2.5NC
6.6*10.4*30.5	4mm	TEN10-04NO		TEN10-04NC		
	E12	4mm	TEN12-04NO	TEN12-04NC		
8*12.4*30.5						
	E15	5mm	TEN15-05NO	TEN15-05NC		
8*15.4*34.5		8mm	TEN15-08NO	TEN15-08NC		
	E16	5mm	TEN16-05NO	TEN16-05NC		
15*16.4*34.5		8mm	TEN16-08NO	TEN16-08NC		

Noted: Model numbers ended with "PO" are PNP normally open ;model numbers ended with"PC" are PNP normally closed.

Mini-cylindrical DC 3-wire



Type	Appearance	Sensing distance	Model numbers		Pages		
			NPN Normally open	NPN Normally closed			
Pre-wired Type	Shielded	Unit: mm					
			φ 3 * 25	0.6mm	TXF03-0.6NO	TXF03-0.6NC	
				0.8mm	TXF03-0.8NO	TXF03-0.8NC	
				1.0mm	TXF03-01NO	TXF03-01NC	
			φ 4 * 25	0.8mm	TXF04-0.8NO	TXF04-0.8NC	
				1.0mm	TXF04-01NO	TXF04-01NC	
				1.2mm	TXF04-1.2NO	TXF04-1.2NC	
				1.5mm	TXF04-1.5NO	TXF04-1.5NC	
				M4 * 25	0.6mm	TXFM4-0.6NO	TXFM4-0.6NC
					0.8mm	TXFM4-0.8NO	TXFM4-0.8NC
		1.0mm	TXFM4-01NO		TXFM4-01NC		
			M5 * 25	0.8mm	TXF05-0.8NO	TXF05-0.8NC	
				1.0mm	TXF05-01NO	TXF05-01NC	
				1.2mm	TXF05-1.2NO	TXF05-1.2NC	
			1.5mm	TXF05-1.5NO	TXF05-1.5NC		

Noted: Model numbers ended with "PO" are PNP normally open ;model numbers ended with"PC" are PNP normally closed.



- Fiber Optic
- Slot Sensors
- Photoelectric
- Laser
- Proximity**
- Displacement
- Magnetic
- Contact
- Area
- Ultrasonic
- Vibration
- Temperature
- Cables
- Tester

Guidance

- Inductive sensors**
- Standard distance
- Extended distance
- Long distance
- Square
- Mini square
- Mini-cylindrical
- Short-body
- Ring-type
- Metal face
- Temperature
- Analog output
- DC 2 wires
- IP69K high protection
- Capacitive sensors**
- Cylindrical
- Correction resistanc type
- Flat type
- Level detection

Type	Appearance	Sensing distance		Model numbers		Pages
		Unit: mm		NPN Normally open	NPN Normally closed	
Pre-wired Type	Shielded		φ 6.5*18	1mm	TSSF6.5-01NO	TSSF6.5-01NC
				2mm	TSSF6.5-02NO	TSSF6.5-02NC
				3mm	TSSF6.5-03NO	TSSF6.5-03NC
			φ 6.5*18	1mm	TSSF6.5Y-01NO	TSSF6.5Y-01NC
				2mm	TSSF6.5Y-02NO	TSSF6.5Y-02NC
				3mm	TSSF6.5Y-03NO	TSSF6.5Y-03NC
		M8*18	1mm	TSSF08-01NO	TSSF08-01NC	
			2mm	TSSF08-02NO HOT	TSSF08-02NC	
		M12*22	2mm	TSSF12-02NO	TSSF12-02NC	
	4mm		TSSF12-04NO	TSSF12-04NC		

Noted: Model numbers ended with "PO" are PNP normally open ;model numbers ended with "PC" are PNP normally closed.

Type	Appearance	Sensing distance		Model numbers		Pages
		Unit: mm		NPN Normally open	NPN Normally closed	
Pre-wired Type	Shielded		M8*35	1mm	TSF08-01NO	TSF08-01NC
				2mm	TSF08-02NO	TSF08-02NC
			M12*35	2mm	TSF12-02NO	TSF12-02NC
				4mm	TSF12-04NO	TSF12-04NC
			M18*35	5mm	TSF18-05NO	TSF18-05NC
				8mm	TSF18-08NO	TSF18-08NC
			M30*35	10mm	TSF30-10NO	TSF30-10NC
				16mm	TSF30-16NO	TSF30-16NC
			Unshielded		M8*35	2mm
	4mm	TSN08-04NO				TSN08-04NC
	M12*35	4mm			TSN12-04NO	TSN12-04NC
		8mm			TSN12-08NO	TSN12-08NC
	M18*43	8mm			TSN18-08NO	TSN18-08NC
		16mm			TSN18-16NO	TSN18-16NC
	M30*47	15mm			TSN30-15NO	TSN30-15NC
		25mm			TSN30-25NO	TSN30-25NC

Noted: Model numbers ended with "PO" are PNP normally open ;model numbers ended with "PC" are PNP normally closed.

- Fiber Optic
- Slot Sensors
- Photoelectric
- Laser
- Proximity**
- Displacement
- Magnetic
- Contact
- Area
- Ultrasonic
- Vibration
- Temperature
- Cables
- Tester

Guidance

Inductive sensors

- Standard distance
- Extended distance
- Long distance
- Square
- Mini square
- Mini-cylindrical
- Short-body
- Ring-type
- Metal face
- Temperature
- Analog output
- DC 2 wires
- IP69K high protection

Capacitive sensors

- Cylindrical
- Correction resistanc type
- Flat type
- Level detection



Guidance

Ring-type DC 3-wire

Type	Appearance	Sensing distance		Model numbers		Pages	
		Unit: mm		NPN Normally open	NPN Normally closed		
Pre-wired Type		H10	Hole height:20	10.5mm	TH10-20NO	TH10-20NC	E-34
		H15	Hole height:20	15.5mm	TH15-20NO	TH15-20NC	
		H21	Hole height:20	22.5mm	TH21-20NO	TH21-20NC	
		H43	Hole height:20	43.5mm	TH43-20NO	TH43-20NC	

Noted: Model numbers ended with "PO" are PNP normally open ;model numbers ended with"PC" are PNP normally closed.



Metal Face DC 3-wire

Type	Appearance	Sensing distance		Model numbers		Pages	
		Unit: mm		NPN Normally open	NPN Normally closed		
Pre-wired Type	Shielded		M8*45	1mm	TMF08-01NO	TMF08-01NC	E-35
				2mm	TMF08-02NO	TMF08-02NC	
			M12*45	2mm	TMF12-02NO	TMF12-02NC	
				4mm	TMF12-04NO	TMF12-04NC	
			M18*54	5mm	TMF18-05NO	TMF18-05NC	
				8mm	TMF18-08NO	TMF18-08NC	
			M30*54	10mm	TMF30-10NO	TMF30-10NC	
	16mm	TMF30-16NO		TMF30-16NC			
	Unshielded		M8*49	2mm	TMN08-02NO	TMN08-02NC	
				3mm	TMN08-03NO	TMN08-03NC	
			M12*54	4mm	TMN12-04NO	TMN12-04NC	
				8mm	TMN12-08NO	TMN12-08NC	
			M18*62	8mm	TMN18-08NO	TMN18-08NC	
				16mm	TMN18-16NO	TMN18-16NC	
M30*66			15mm	TMN30-15NO	TMN30-15NC		
	25mm	TMN30-25NO	TMN30-25NC				

Noted: Model numbers ended with "PO" are PNP normally open ;model numbers ended with"PC" are PNP normally closed.

- Fiber Optic
- Slot Sensors
- Photoelectric
- Laser
- Proximity
- Displacement
- Magnetic
- Contact
- Area
- Ultrasonic
- Vibration
- Temperature
- Cables
- Tester
- Guidance
- Inductive sensors
 - Standard distance
 - Extended distance
 - Long distance
 - Square
 - Mini square
 - Mini-cylindrical
 - Short-body
 - Ring-type
 - Metal face
 - Temperature
 - Analog output
 - DC 2 wires
 - IP69K high protection
- Capacitive sensors
 - Cylindrical
 - Correction resistanc type
 - Flat type
 - Level detection

DC 3-wire **Temperature Resistance**

	Type	Appearance	Sensing distance		Model numbers		Pages
			Unit: mm		NPN Normally open	NPN Normally closed	
High temperature resistant	Shielded		M12*54	2mm	TGF12-02NO	TGF12-02NC	E-37
			M18*55	5mm	TGF18-05NO	TGF18-05NC	
			M30*51.5	10mm	TGF30-10NO	TGF30-10NC	
	Unshielded		M12*51	4mm	TGN12-04NO	TGN12-04NC	
			M18*51.5	8mm	TGN18-08NO HOT	TGN18-08NC	
			M30*51.5	15mm	TGN30-15NO	TGN30-15NC	
	Shielded		M12*55	2mm	TGF12-02NO2	TGF12-02PO2	
			M18*55	5mm	TGF18-05NO2	TGF18-05PO2	
			M30*54	10mm	TGF30-10NO2	TGF30-10PO2	

Noted: Model numbers ended with "PO" are PNP normally open ; model numbers ended with "PC" are PNP normally closed.

IP69K High Protection

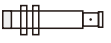
	Type	Appearance	Sensing distance		Model numbers		Pages
			Unit: mm		NPN	PNP	
Pre-wired Type	Shielded		M12*64.6	2mm	TPF12-02NR-E2	TPF12-02PR-E2	E-39
				4mm	TPF12-04NR-E2	TPF12-04PR-E2	
			M18*63.1	5mm	TPF18-05NR-E2	TPF18-05PR-E2	E-40
				8mm	TPF18-08NR-E2	TPF18-08PR-E2	
	Unshielded		M12*64.6	4mm	TPN12-04NR-E2	TPN12-04PR-E2	E-39
				8mm	TPN12-08NR-E2	TPN12-08PR-E2	
			M18*63.1	8mm	TPN18-08NR-E2	TPN18-08PR-E2	E-40
				12mm	TPN18-12NR-E2	TPN18-12PR-E2	

Note: The model ending with **NR-E2 is NPN normally open + normally closed; the model ending with **PR-E2 is PNP normally open + normally closed.

DC 3-wire **Analog Output**

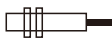
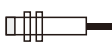
	Type	Appearance	Sensing distance		Model numbers		Pages
			Unit: mm		PNP Current output	PNP Voltage output	
Pre-wired Type	Shielded		M12*45	3mm	TAF12-03PA	TAF12-03PV	E-41
			M18*54	4mm	TAF18-04PA	TAF18-04PV	
			M30*54	10mm	TAF30-10PA	TAF30-10PV	
	Unshielded		M12*44	4mm	TAN12-04PA	TAN12-04PV	
			M18*54	7mm	TAN18-07PA	TAN18-07PV	
			M30*58	14mm	TAN30-14PA	TAN30-14PV	







- Fiber Optic
- Slot Sensors
- Photoelectric
- Laser
- Proximity**
- Displacement
- Magnetic
- Contact
- Area
- Ultrasonic
- Vibration
- Temperature
- Cables
- Tester

Guidance

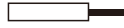
- Inductive sensors**
- Standard distance
- Extended distance
- Long distance
- Square
- Mini square
- Mini-cylindrical
- Short-body
- Ring-type
- Metal face
- Temperature
- Analog output
- DC 2 wires
- IP69K high protection

- Capacitive sensors**
- Cylindrical
- Correction resistanc type
- Flat type
- Level detection

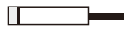
DC 2-Wire

Type	Appearance	Sensing distance		Model numbers		Pages	
		Unit: mm		Normally open	Normally closed		
Pre-wired Type	Shielded		φ 6.5*45	1mm	TDF6.5-01HO	TDF6.5-01HC	F-42
				2mm	TDF6.5-02HO	TDF6.5-02HC	
			M8*45	1mm	TDF08-01HO	TDF08-01HC	
				2mm	TDF08-02HO	TDF08-02HC	
			M12*45	2mm	TDF12-02HO	TDF12-02HC	
				4mm	TDF12-04HO	TDF12-04HC	
			M18*54	5mm	TDF18-05HO	TDF18-05HC	
				8mm	TDF18-08HO	TDF18-08HC	
		Unshielded		φ 6.5*44	2mm	TDN6.5-02HO	
				4mm	TDN6.5-04HO	TDN6.5-04HC	
			M8*44	2mm	TDN08-02HO	TDN08-02HC	
				4mm	TDN08-04HO	TDN08-04HC	
			M12*44	4mm	TDN12-04HO	TDN12-04HC	
				8mm	TDN12-08HO	TDN12-08HC	
			M18*54	8mm	TDN18-08HO	TDN18-08HC	
				16mm	TDN18-16HO	TDN18-16HC	
			M30*58	15mm	TDN30-15HO	TDN30-15HC	
		25mm	TDN30-25HO	TDN30-25HC			





- Fiber Optic
- Slot Sensors
- Photoelectric
- Laser
- Proximity**
- Displacement
- Magnetic
- Contact
- Area
- Ultrasonic
- Vibration
- Temperature
- Cables
- Tester

Guidance

- Inductive sensors**
- Standard distance
 - Extended distance
 - Long distance
 - Square
 - Mini square
 - Mini-cylindrical
 - Short-body
 - Ring-type
 - Metal face
 - Temperature
 - Analog output
 - DC 2 wires
 - IP69K high protection

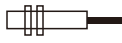
- Capacitive sensors**
- Cylindrical
 - Correction resistanc type
 - Flat type
 - Level detection

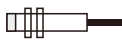
DC 3-wire **Cylindrical**

Type	Appearance	Sensing distance	Model numbers		Pages	
			NPN Normally open	NPN Normally closed		
Plastic Shells	Shielded	 M12*55	3mm	CKF12-03NO	CKF12-03NC	E-44
		 M18*70	8mm	CKF18-08NO	CKF18-08NC	
		 M30*80	20mm	CKF30-20NO	CKF30-20NC	
	Unshielded	 M12*59	6mm	CKN12-06NO	CKN12-06NC	
		 M18*73	15mm	CKN18-15NO	CKN18-15NC	
		 M30*82	30mm	CKN30-30NO	CKN30-30NC	

Noted: Model numbers ended with "PO" are PNP normally open ; model numbers ended with "PC" are PNP normally closed.

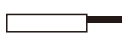

DC 4-wire **Corrosion Resistant Type**

Type	Appearance	Sensing distance	Model numbers		Pages
Teflon casing Shielded		M18*70.5	10mm	CWF18-10NP	E-45

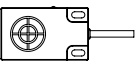
DC 3-wire **Flat Type**

Appearance	Sensing distance	Model numbers			Pages
		NPN Normally open	NPN Normally closed	PNP Normally open	
	5mm	CQ07-05NO			F-46
	6mm	CQ07-06NO			
	7mm		CQ07-07NC	CQ07-07PO	
	10mm		CQ07-10NC	CQ07-10PO	

DC 3-wire **Liquid Level Detection**

Type	Appearance	Exterior diameter of pipes	Model numbers		Pages
Unshielded		φ 8~ φ 11	CE15-13NO	CE15-13NC	F-47
		φ 12~ φ 26	CE30-26NO 	CE30-26NC	

Noted: Model numbers ended with "PO" are PNP normally open ; model numbers ended with "PC" are PNP normally closed.

- Fiber Optic
- Slot Sensors
- Photoelectric
- Laser
- Proximity
- Displacement
- Magnetic
- Contact
- Area
- Ultrasonic
- Vibration
- Temperature
- Cables
- Tester

Guidance

- Inductive sensors
- Standard distance
- Extended distance
- Long distance
- Square
- Mini square
- Mini-cylindrical
- Short-body
- Ring-type
- Metal face
- Temperature
- Analog output
- DC 2 wires
- IP69K high protection

Capacitive sensors

- Cylindrical
- Correction resistant type
- Flat type
- Level detection

Input/Output Circuit

DC 4-Wire

NPN Output

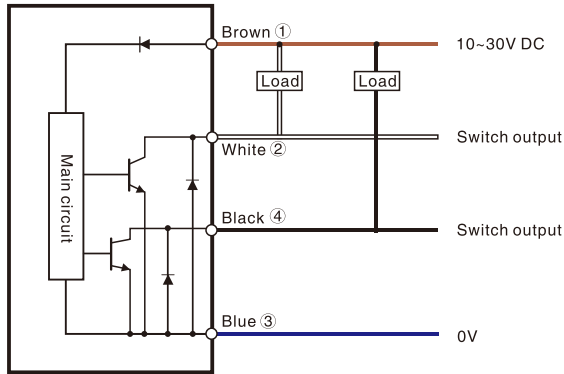

PNP Output

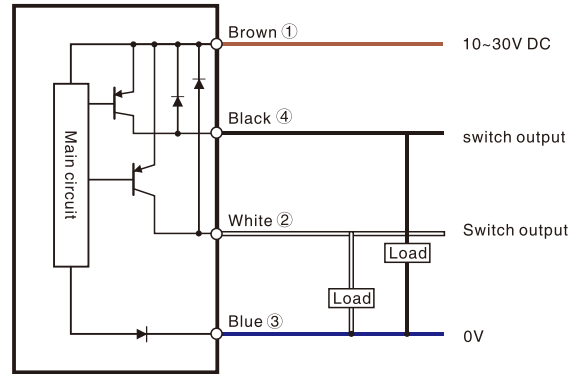

DC 3-Wire

NPN Output

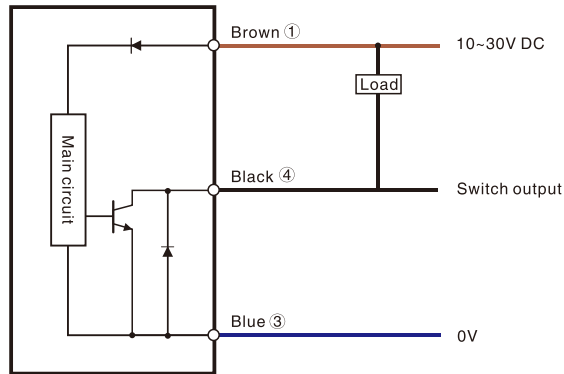

PNP Output

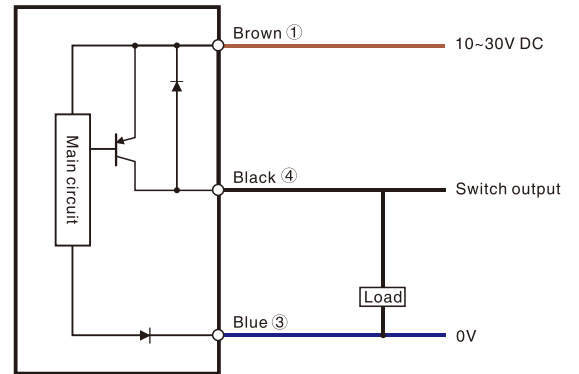

DC 2-Wire

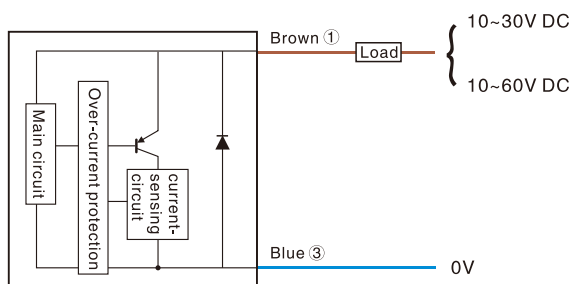

*Load (can be connected between blue wire and negative power supply.)
M8 sensor does not include short-circuit protection or current detection circuit. 1 and 4 in the circuit diagram show the connection of the connector type.

Analog

3-wire Voltage output	
3-wire Current output	
4-wire Voltage/current output	

Configuration of Connector Type Sensor

Note: Terminal 1 and 4 are used in connector models

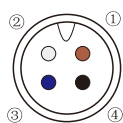

M12 4 pin

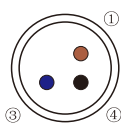

M8 3 pin

Inductance Attenuation Coefficient

Sensing distance=Nominal sensing distance*Attenuation factor

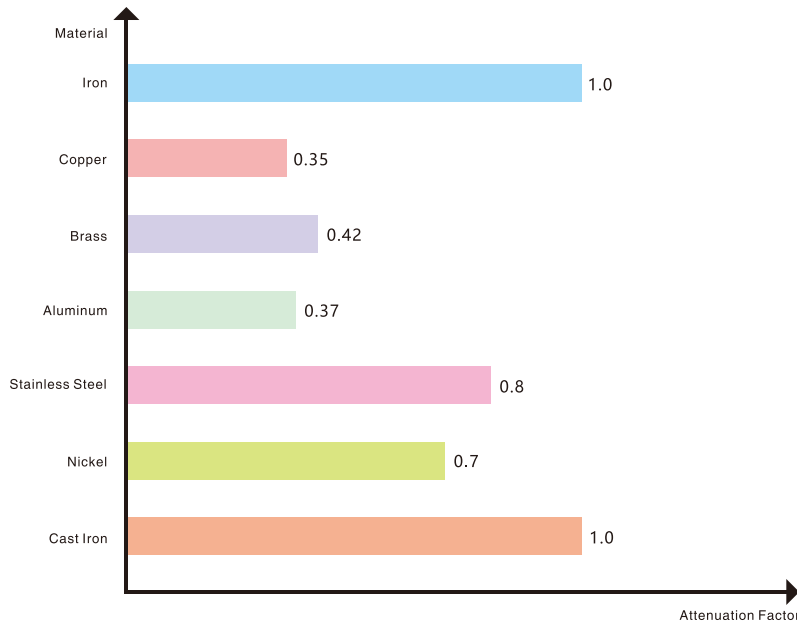

Note:
 1. Proper installation: shielded or unshielded
 2. Specifications
 3. Sensing distance
 4. Feature of detecting objects(material and size)

Capacitive Sensors Dielectric Constant

For capacitive sensors, the sensing distance and sensitivity vary due to changes in the dielectric constant of the target object. The bigger the dielectric constant of the target object, the farther the sensing distance of the sensor

Dielectric Constant chart

Material	Dielectric Constant
Air	1
Wood	2~7
Paper	2.3
Polypropylene	2.3
Rubber, neoprene	2.5
Porcelain	4.4
Glass, pyrex	5
Water	80

- Fiber Optic
- Slot Sensors
- Photoelectric
- Laser
- Proximity**
- Displacement
- Magnetic
- Contact
- Area
- Ultrasonic
- Vibration
- Temperature
- Cables
- Tester

Guidance

- Inductive sensors**
- Standard distance
- Extended distance
- Long distance
- Square
- Mini square
- Mini-cylindrical
- Short-body
- Ring-type
- Metal face
- Temperature
- Analog output
- DC 2 wires
- IP69K high protection

- Capacitive sensors**
- Cylindrical
- Correction resistanc type
- Flat type
- Level detection

Mounting Method-Shielded, Unshielded

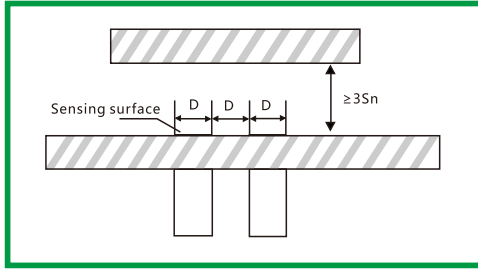

Shielded Mounting Proximity Sensors

Sensing surface must be flush with metal surface

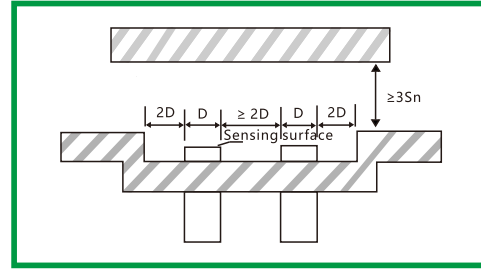

Unshielded Mounting Proximity Sensors

The distance between sensing surface to surrounding metals must be more than 2 times sensing distance

Mounting Torque

Cylindrical Type

1. $\phi 3/3.4/4$: Fix the sensing head with a screw at 7mm where it is near the pointed part;
2. $\phi 6.5$ Shielded mounting: Fix the sensing head with a screw at 8mm where it is near the pointed part;
3. $\phi 6.5$ Unshielded mounting: Fix the sensing head with a screw at 12mm where it is near the pointed part.

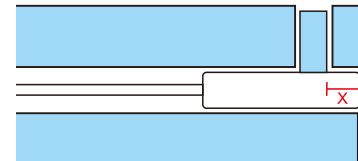

$\phi 3/ \phi 3.4/ \phi 4$: X=7mm $\phi 6.5$: X=8-12mm

Thread Type

When installing a threaded sensor, please do not exceed the torque listed below.

Model No.	Tightening torque N
M4*0.5	1.5
M5*0.5	1.5
M8*1	3.5
M12*1	16
M18*1	28
M30*1.5	150

- Fiber Optic
- Slot Sensors
- Photoelectric
- Laser
- Proximity**
- Displacement
- Magnetic
- Contact
- Area
- Ultrasonic
- Vibration
- Temperature
- Cables
- Tester

Guidance

- Inductive sensors**
 - Standard distance
 - Extended distance
 - Long distance
 - Square
 - Mini square
 - Mini-cylindrical
 - Short-body
 - Ring-type
 - Metal face
 - Temperature
 - Analog output
 - DC 2 wires
 - IP69K high protection
- Capacitive sensors**
 - Cylindrical
 - Correction resistanc type
 - Flat type
 - Level detection

Capacitive Sensors



No.	Classification	Explanation of model numbers
①	Series	A: Analog Output D: DC 2-wire E: Mini Square G: High-temperature Resistant H: Ring-type L: Extended Distance M: Metal Face Q: Square R: Standard Distance S: Short-body SS: Extra Short Outer Casing X: Mini-cylindrical Y: Long Distance Z: Low Temperature Resistant
②	Mounting	F: Shielded N: Unshielded
③	Specifications	08: M8 12: M12 18: M18 30: M30
④	Sensing Distance	1.5: 1.5mm 02: 2mm 05: 5mm 08: 8mm
⑤	Output Type	N: NPN P: PNP H: DC 2-Wire
⑥	Output Status	O: Normally open C: Normally closed A: Current output V: Voltage output
⑦	Connection	Null: Pre-wired type E1: M8 3 pin connector E2: M12 4 pin connector

- Fiber Optic
- Slot Sensors
- Photoelectric
- Laser
- Proximity**
- Displacement
- Magnetic
- Contact
- Area
- Ultrasonic
- Vibration
- Temperature
- Cables
- Tester

Guidance

- Inductive sensors**
- Standard distance
- Extended distance
- Long distance
- Square
- Mini square
- Mini-cylindrical
- Short-body
- Ring-type
- Metal face
- Temperature
- Analog output
- DC 2 wires
- IP69K high protection

- Capacitive sensors**
- Cylindrical
- Correction resistant type
- Flat type
- Level detection

Capacitive Sensors



No.	Classification	Explanation of model numbers
①	Series	E: Liquid Level Detection K: Plastic Shells Q: Flat Type W: Corrosion resistant
②	Mounting	F: Shielded N: Unshielded
③	Specifications	08: M8 12: M12 18: M18 30: M30
④	Sensing Distance	1.5: 1.5mm 02: 2mm 05: 5mm 08: 8mm
⑤	Output Type	N: NPN P: PNP H: DC 2-Wire
⑥	Output Status	O: Normally open C: Normally closed
⑦	Connection	Null: Pre-wired type E1: M8 3 pin connector E2: M12 4 pin connector

Standard Distance

Pre-wired

Proximity



Appearance										
Mounting	Shielded		Shielded			Unshielded		Unshielded		
Housing size	φ 6.5	M8	M12	M18	M30	φ 6.5	M8	M12	M18	M30
Sensing distance	1.5mm ± 10%	1.5mm ± 10%	2mm ± 10%	5mm ± 10%	10mm ± 10%	2mm ± 10%	2mm ± 10%	4mm ± 10%	8mm ± 10%	15mm ± 10%
Housing material	Stainless steel		Nickel copper alloy			Stainless steel		Nickel copper alloy		
Operating voltage	10~30V DC(Ripple < 10%)									
Voltage drop	< 1.5V		< 2.0V			< 1.5V		< 2.0V		
Load Current, Max	150mA									
Current consumption	< 10mA							< 20mA		
Leakage current	< 0.01mA									
Switch frequency	2KHz		1KHz		300Hz	2KHz	1KHz	800Hz	500Hz	150Hz
Repeat accuracy	< 1.0% (Sr)							< 5.0% (Sr)		< 1.0% (Sr)
Hysteresis	< 15% (Sr)									
Sensing surface material	PBT									
Operating temperature	-25°C~+75°C									
Protective circuit	Short circuit									
Degree of protection	IP67									
Area	<div style="display: flex; justify-content: space-between;"> Model No. NPN Normally open TRF6.5-1.5[NIO] TRF08-1.5[NIO] TRF12-02[NIO] TRF18-05[NIO] TRF30-10[NIO] TRN6.5-02[NIO] TRN08-02[NIO] TRN12-04[NIO] TRN18-08[NIO] TRN30-15[NIO] </div>									
Others	<div style="display: flex; justify-content: space-between;"> [NIO]:NPN Normally open [NIC]:NPN Normally closed [PIO]:PNP Normally open [PIC]:PNP Normally closed </div>									

Connector Type

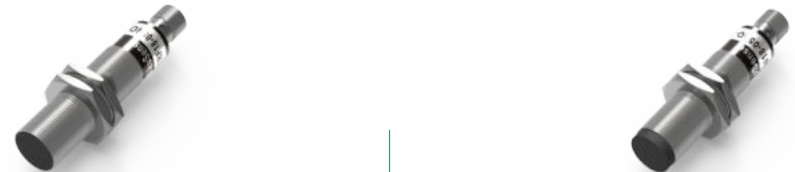

Appearance												
Mounting	Shielded								Unshielded			
Housing size	M8	M12	M18	M30	M8	M12	M18	M30				
Sensing distance	1.5mm ± 10%	2mm ± 10%	5mm ± 10%	10mm ± 10%	2mm ± 10%	4mm ± 10%	8mm ± 10%	15mm ± 10%				
Housing material	Stainless steel	Nickel copper alloy			Stainless steel	Nickel copper alloy						
Operating voltage	10~30V DC(Ripple < 10%)											
Voltage drop	< 1.5V											
Load Current Max	150mA											
Current consumption	< 10mA											
Leakage current	< 0.01mA											
Switch frequency	2KHz		1KHz		300Hz	2KHz	1KHz	500Hz	150Hz			
Repeat accuracy	< 1.0% (Sr)											
Hysteresis	< 15% (Sr)											
Sensing surface material	PBT											
Operating temperature	-25°C~+75°C											
Protective circuit	Short circuit											
Degree of protection	IP67											
Area	<div style="display: flex; justify-content: space-between;"> Model No. NPN Normally open TRF08-1.5[NIO]-E1 TRF12-02[NIO]-E2 TRF18-05[NIO]-E2 TRF30-10[NIO]-E2 TRN08-02[NIO]-E1 TRN12-04[NIO]-E2 TRN18-08[NIO]-E2 TRN30-15[NIO]-E2 </div>											
Others	<div style="display: flex; justify-content: space-between;"> [NIO]:NPN Normally open [NIC]:NPN Normally closed [PIO]:PNP Normally open [PIC]:PNP Normally closed </div>											

φ6.5

TRF6.5-1.5□□

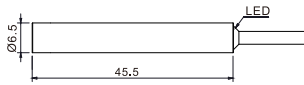

TRN6.5-02□□

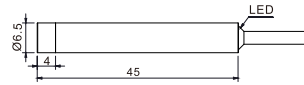

M8

TRF08-1.5□□

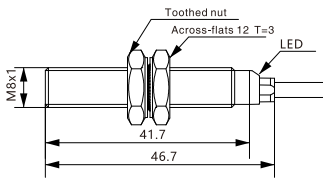

TRN08-02□□

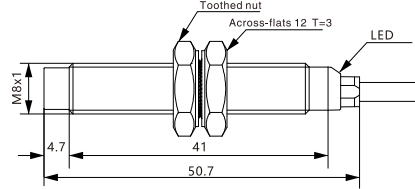

M12

TRF12-02□□

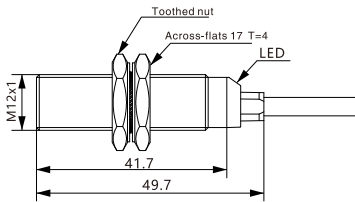

TRN12-04□□

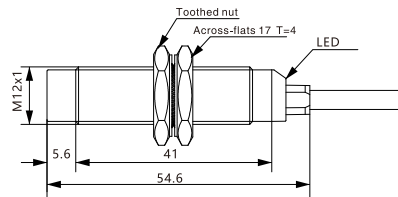

M18

TRF18-05□□

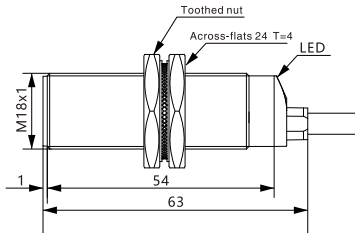

TRN18-08□□

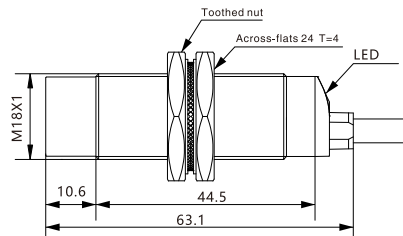

M30

TRF30-10□□

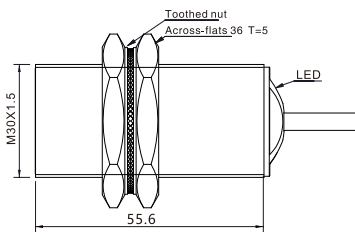

TRN30-15□□

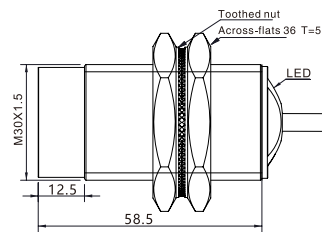

Fiber Optic
Slot Sensors
Photoelectric
Laser
Proximity
Displacement
Magnetic
Contact
Area
Ultrasonic
Vibration
Temperature
Cables
Tester

Guidance

Inductive sensors
Standard distance
Extended distance
Long distance
Square
Mini square
Mini-cylindrical
Short-body
Ring-type
Metal face
Temperature
Analog output
DC 2 wires
IP69K high protection

Capacitive sensors
Cylindrical
Correction resistanc type
Flat type
Level detection

Standard Distance

Dimensions- Connector Type (Unit:mm)

M8

TRF08-1.5□□-E1

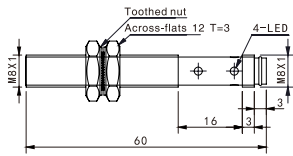

TRN08-02□□-E1

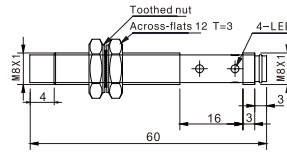

M12

TRF12-02□□-E2

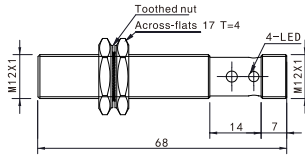

TRN12-04□□-E2

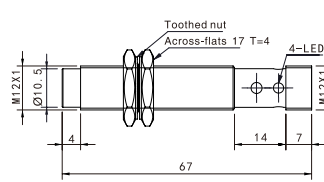

M18

TRF18-05□□-E2

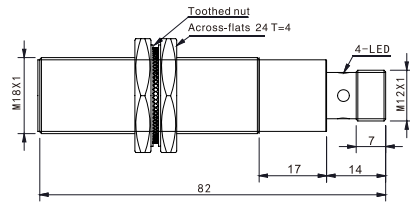

TRN18-08□□-E2

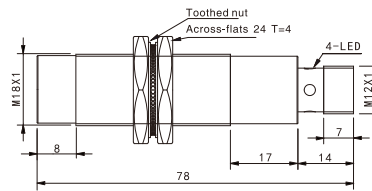

M30

TRF30-10□□-E2

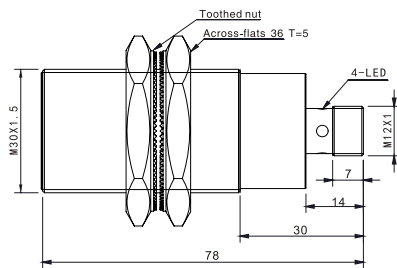

TRN30-15□□-E2

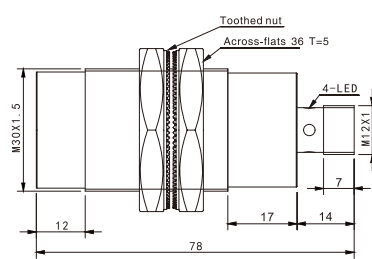

- Fiber Optic
- Slot Sensors
- Photoelectric
- Laser
- Proximity**
- Displacement
- Magnetic
- Contact
- Area
- Ultrasonic
- Vibration
- Temperature
- Cables
- Tester

Guidance

- Inductive sensors
- Standard distance**
- Extended distance
- Long distance
- Square
- Mini square
- Mini-cylindrical
- Short-body
- Ring-type
- Metal face
- Temperature
- Analog output
- DC 2 wires
- IP69K high protection

Capacitive sensors

- Cylindrical
- Correction resistanc type
- Flat type
- Level detection

Appearance																					
Mounting	Shielded		Shielded			Unshielded		Unshielded													
Housing size	φ 6.5	M8	M12	M18	M30	φ 6.5	M8	M12	M18	M30											
Sensing distance	2mm ± 10%	2mm ± 10%	4mm ± 10%	8mm ± 10%	16mm ± 10%	4mm ± 10%	4mm ± 10%	8mm ± 10%	16mm ± 10%	25mm ± 10%											
Housing material	Stainless steel		Nickel copper alloy			Stainless steel		Nickel copper alloy													
Operating voltage	10~30V DC(Ripple < 10%)																				
Voltage drop	< 1.5V		< 2.0V			< 1.5V		< 2.0V													
Load Current, Max	150mA																				
Current consumption	< 10mA																				
Leakage current	< 0.01mA																				
Switch frequency	2KHz	1KHz	800Hz	500Hz	150Hz	1KHz	800Hz	300Hz	150Hz	100Hz											
Repeat accuracy	< 1.0%(Sr)		< 5.0%(Sr)			< 1.0%(Sr)		< 5.0%(Sr)		< 1.0%(Sr)											
Hysteresis	< 15%(Sr)																				
Sensing surface material	PBT																				
Operating temperature	-25°C~+75°C																				
Protective circuit	Short circuit																				
Degree of protection	IP67																				
Model No.	NPN Normally open	TLF6.5-02	NO	TLF08-02	NO	TLF12-04	NO	TLF18-08	NO	TLF30-16	NO	TLN6.5-04	NO	TLN08-04	NO	TLN12-08	NO	TLN18-16	NO	TLN30-25	NO
	Others	NO:NPN Normally open		NC:NPN Normally closed			PO:PNP Normally open		PC:PNP Normally closed												

- Fiber Optic
- Slot Sensors
- Photoelectric
- Laser
- Proximity**
- Displacement
- Magnetic
- Contact
- Area
- Ultrasonic
- Vibration
- Temperature
- Cables
- Tester

Connector Type

Appearance																	
Mounting	Shielded									Unshielded							
Housing size	M8	M12	M18	M30	M8	M12	M18	M30									
Sensing distance	2mm ± 10%	4mm ± 10%	8mm ± 10%	16mm ± 10%	4mm ± 10%	8mm ± 10%	16mm ± 10%	25mm ± 10%									
Housing material	Stainless steel	Nickel copper alloy			Stainless steel	Nickel copper alloy											
Operating voltage	10~30V DC(Ripple < 10%)																
Voltage drop	< 1.5V																
Load Current, Max	150mA																
Current consumption	< 10mA																
Leakage current	< 0.01mA																
Switch frequency	2KHz	1KHz	500Hz	150Hz	1KHz	500Hz	150Hz	100Hz									
Repeat accuracy	< 1.0%(Sr)																
Hysteresis	< 15%(Sr)																
Sensing surface material	PBT																
Operating temperature	-25°C~+75°C																
Protective circuit	Short circuit																
Degree of protection	IP67																
Model No.	NPN Normally open	TLF08-02	NO	TLF12-04	NO	TLF18-08	NO	TLF30-16	NO	TLN08-04	NO	TLN12-08	NO	TLN18-16	NO	TLN30-25	NO
	Others	NO:NPN Normally open		NC:NPN Normally closed			PO:PNP Normally open		PC:PNP Normally closed								

Guidance

- Inductive sensors
- Standard distance
- Extended distance**
- Long distance
- Square
- Mini square
- Mini-cylindrical
- Short-body
- Ring-type
- Metal face
- Temperature
- Analog output
- DC 2 wires
- IP69K high protection
- Capacitive sensors
- Cylindrical
- Correction resistanc type
- Flat type
- Level detection

Extended Distance

Dimensions-Pre-wired Type (Unit:mm)

φ6.5

TLF6.5-02□□

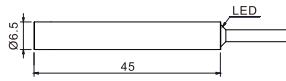

TLN6.5-04□□

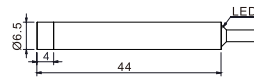

M8

TLF08-02□□

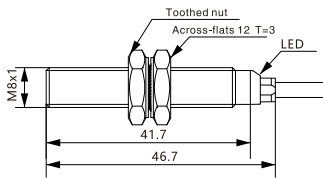

TLN08-04□□

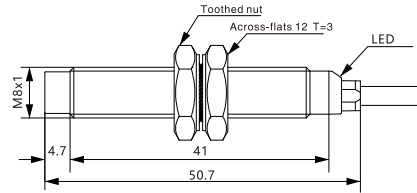

M12

TLF12-04□□

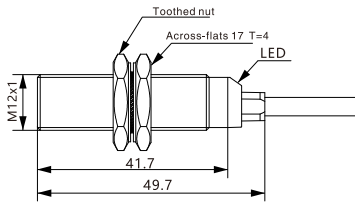

TLN12-08□□

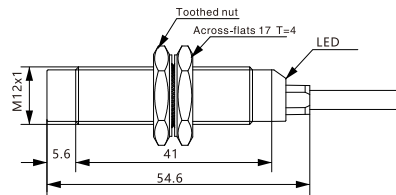

M18

TLF18-08□□

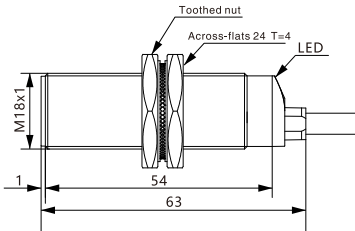

TLN18-16□□

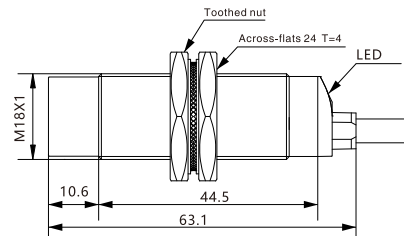

M30

TLF30-16□□

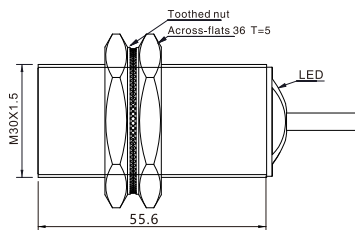

TLN30-25□□

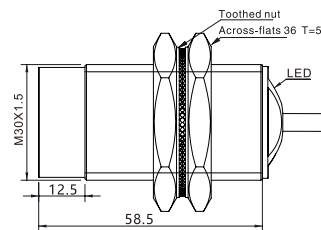

- Fiber Optic
- Slot Sensors
- Photoelectric
- Laser
- Proximity**
- Displacement
- Magnetic
- Contact
- Area
- Ultrasonic
- Vibration
- Temperature
- Cables
- Tester

Guidance

- Inductive sensors
- Standard distance
- Extended distance**
- Long distance
- Square
- Mini square
- Mini-cylindrical
- Short-body
- Ring-type
- Metal face
- Temperature
- Analog output
- DC 2 wires
- IP69K high protection

- Capacitive sensors
- Cylindrical
- Correction resistant type
- Flat type
- Level detection

Dimensions- Connector Type (Unit:mm)

M8

TLF08-02□□-E1

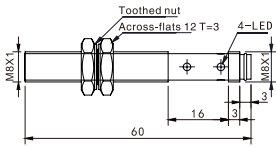

TLN08-04□□-E1

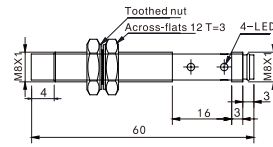

M8 3 Pin

M12

TLF12-04□□-E2

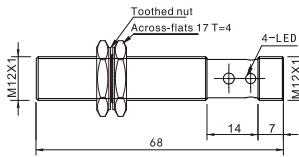

TLN12-08□□-E2

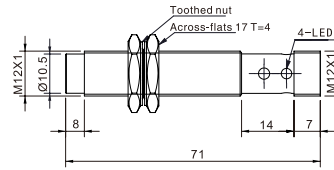

M12 4 Pin

M18

TLF18-08□□-E2

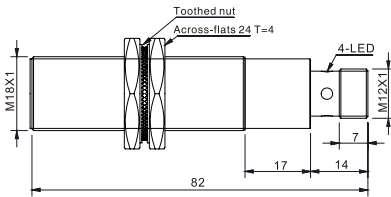

TLN18-16□□-E2

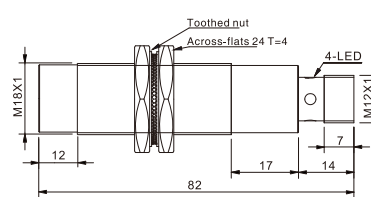

M12 4 Pin

M30

TLF30-16□□-E2

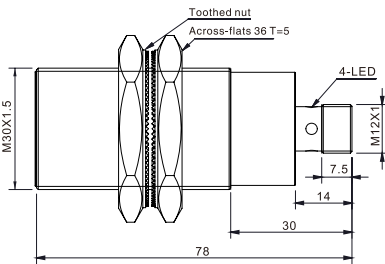

TLN30-25□□-E2

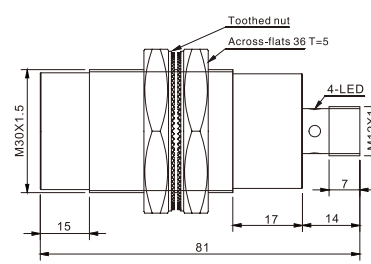

M12 4 Pin

- Fiber Optic
- Slot Sensors
- Photoelectric
- Laser
- Proximity**
- Displacement
- Magnetic
- Contact
- Area
- Ultrasonic
- Vibration
- Temperature
- Cables
- Tester

Guidance

Inductive sensors

- Standard distance
- Extended distance**
- Long distance
- Square
- Mini square
- Mini-cylindrical
- Short-body
- Ring-type
- Metal face
- Temperature
- Analog output
- DC 2 wires
- IP69K high protection

Capacitive sensors

- Cylindrical
- Correction resistanc type
- Flat type
- Level detection